

# Journal of Engineering and Technology for Industrial Applications



**ISSN 2447-0228**

**February 2021**

**Volume 07 / No 27**

**Editor-in-Chief: J. C. Leite**

**[www.itegam-jetia.org](http://www.itegam-jetia.org)**



O **ITEGAM-JETIA: Journal of Engineering and Technology for Industrial Applications** is a publication of the Galileo Institute of Technology and Education of the Amazon (ITEGAM), located in the city of Manaus since 2008. JETIA publishes original scientific articles covering all aspects of engineering. Our goal is the dissemination of research original, useful and relevant presenting new knowledge on theoretical or practical aspects of methodologies and methods used in engineering or leading to improvements in professional practice. All the conclusions presented in the articles It should be state-of-the-art and supported by current rigorous analysis and balanced assessment. Public magazine scientific and technological research articles, review articles and case studies.

**JETIA** will address topics from the following areas of knowledge: Mechanical Engineering, Civil Engineering, Materials and Mineralogy, Geosciences, Environment, Information and Decision Systems, Processes and Energy, Electrical and Automation, Mechatronics, Biotechnology and other Engineering related areas.

**Publication Information:**

**ITEGAM-JETIA** (ISSN 2447-0228), (online) is published by Galileo Institute of Technology and Education of the Amazon on a every two months (February, April, June, August, October and December).

**Contact information:**

Web page: [www.itegam-jetia.org](http://www.itegam-jetia.org)

Email: [editor@itegam-jetia.org](mailto:editor@itegam-jetia.org)

Galileo Institute of Technology and Education of the Amazon (ITEGAM).

Joaquim Nabuco Avenue, No. 1950. Center. Manaus, Amazonas. Brazil.

Zip Code: 69020-031. Phone: (92) 3584-6145.

**Copyright 2014. Galileo Institute of Technology and Education of the Amazon (ITEGAM)**

The total or partial reproduction of texts related to articles is allowed, only if the source is properly cited. The concepts and opinions expressed in the articles are the sole responsibility of the authors.

**Previous Notice**

All statements, methods, instructions and ideas are the sole responsibility of the authors and do not necessarily represent the view of ITEGAM -JETIA. The publisher is not responsible for any damage and / or damage to the use of the contents of this journal. The concepts and opinions expressed in the articles are the sole responsibility of the authors.

**Directory**

Members of the ITEGAM Editorial Center - Journal of Engineering and Technology for Industrial Applications (ITEGAM-JETIA) of the Galileo Institute of Technology and Education of the Amazon (ITEGAM). Manaus-Amazonas, Brazil.

**Jandecy Cabral Leite**, CEO and Editorial Editor-in-Chief

**Ivan Leandro Rodriguez Rico**, Editorial Assistant

**Ricardo Silva Parente**, Information Technology Assistant



ITEGAM-JETIA. v.7, n.27. February of 2021. Manaus - Amazonas, Brazil. ISSN 2447-0228 (ONLINE)  
<https://www.itegam-jetia.org>

## SUMMARY

<b>COMPARISON OF MAXIMUM POWER POINT TRACKING TECHNIQUES USED IN PHOTOVOLTAIC SYSTEM</b>	<b>4</b>
<i>Miguel Aybar Mejias, Yandi Gallego Landera and Lesyani León Viltres</i>	
<b>SCADA SYSTEM FOR CHEMICAL WATER TREATMENT PLANT OF THE THERMOELECTRIC POWER PLANT “JOSÉ MARTÍ”</b>	<b>13</b>
<i>Marcel Pérez Vazquez and Roberto Luís Ballesteros Horta</i>	
<b>ROAD SAFETY STATUS AND SOME INITIATIVES IN NEPAL</b>	<b>20</b>
<i>Krishna Nath Ojha</i>	
<b>MOVING VEHICLE DETECTION FROM VIDEO SEQUENCES FOR TRAFFIC SURVEILLANCE SYSTEM</b>	<b>41</b>
<i>Jency Rubia J, Babitha Lincy R and Ahmed Thair Al-Heety</i>	
<b>PREDICTING PROTEIN SECONDARY STRUCTURE BASED ON ENSEMBLE NEURAL NETWORK</b>	<b>49</b>
<i>Emmanuel Gbenga Dada, David Opeoluwa Oyewola, Joseph Hurcha Yakubu and Ayotunde Alaba Fadele</i>	
<b>THE ANALYSIS OF THE RECENT PERIODS OF WHEAT MARKET IN TURKEY</b>	<b>57</b>
<i>Mehmet Cançelik, Zeliha Şahin, Mehmet Reşit Sevinç, Nihat Küçük and Mustafa Hakkı Aydoğdu</i>	
<b>OPEN-SOURCE SOFTWARE IN EMERGING TECHNOLOGIES FOR ECONOMIC GROWTH</b>	<b>63</b>
<i>Eseosa Ehioghae and Sunday Idowu</i>	



ISSN ONLINE: 2447-0228



## COMPARISON OF MAXIMUM POWER POINT TRACKING TECHNIQUES USED IN PHOTOVOLTAIC SYSTEM

Miguel Aybar Mejias<sup>1</sup>, Yandi Gallego Landera<sup>2</sup> and Lesyani León Viltre\*<sup>3</sup>

<sup>1</sup> Santo Domingo Technological Institute – INTEC. Santo Domingo, Dominican Republic.

<sup>2</sup> Federal University of Pernambuco - UFPE. Recife, Brazil.

<sup>3</sup> Marta Abreu de las Villas Central University - UCLV. Villa Clara, Cuba.

<sup>1</sup> <http://orcid.org/0000-0002-4715-3499> , <sup>2</sup> <http://orcid.org/0000-0002-9576-4796> , <sup>3</sup> <http://orcid.org/0000-0003-1822-2480> 

Email: miguel.aybar@intec.edu.do, yandigallego@gmail.com, \*lesyani@uclv.edu.cu

### ARTICLE INFO

#### Article History

Received: December 08<sup>th</sup>, 2020

Accepted: February 01<sup>th</sup>, 2021

Published: February 15<sup>th</sup>, 2021

#### Keywords:

Photovoltaic Systems,  
Maximum Power Point (MPPT),  
Control Algorithms,  
Renewable Energy.

### ABSTRACT

Among the various renewable energy sources, photovoltaic (PV) systems are experiencing a great expansion, due to their low polluting levels, the abundance of solar energy and the cost decreasing of PV technologies, attracting research and investments in the field. The maximum power generated in a PV panel varies according to irradiation and temperature. Since the conversion efficiency of photovoltaic modules is low, it is necessary to implement sophisticated control techniques for monitoring the maximum power point (MPPT). Maximum power point tracking techniques are automatic control algorithms that adjust power interfaces to achieve the maximum power generation, during variations in irradiation, temperature, and characteristics of the photovoltaic module. The purpose of the MPPT is to adjust the solar panel operating voltage near the maximum power point (MPP) according to environmental conditions. This technique has become an essential component in photovoltaic power system designs. This article presents comparison of the performance of various MPPT tracking methods in photovoltaic systems using the MATLAB/Simulink software and a comparative approach.



Copyright ©2016 by authors and Galileo Institute of Technology and Education of the Amazon (ITEGAM). This work is licensed under the Creative Commons Attribution International License (CC BY 4.0).

### I. INTRODUCTION

The use of photovoltaic (PV) systems has been growing in the last decade. However, this type of generation has two critical disadvantages: the high cost of installed capacity and efficiency ranges between 9%–15% [1], which is considered low. Considering the above, it requires the use of maximum power point tracking techniques (MPPT) to generate maximum power according to the variable environmental conditions [2]. In this way, methods such as Perturb & Observe and incremental conductance have been widely used because they are easy to implement and converge quickly the MPP [3-6]. However, in some situations, the photovoltaic system may be subject to variations in irradiation and temperature, and a point different from the point of maximum power may follow its output characteristic curve [6-8]. That is why this article does not just seek to present several of the most used methods in the literature, but to compare them computationally, using reliable and internationally consolidated software. Six MPPT methods applied to a buck-type system connected to a photovoltaic

generator will be presented and simulated in MATLAB/Simulink. Finally, a comparison will be made between the simulated methods.

### II. THEORETICAL REFERENCE

The MPPT methods consists of a DC/DC converter comprising a stage that liaison algorithm that receives information from the photovoltaic system, and a second power stage responsible for requesting the voltage and current that correspond to the desired values according to the environmental conditions of temperature and irradiation.

The objective is to analyze its response to variations in temperature and irradiance. Of the selected methods two are of constant relationship: constant cyclic ratio ( $R_{cte}$ ) and constant voltage ( $V_{cte}$ ), the rest of the chosen methods: Perturb & Observe classic (P&OC), Perturb & Observe modified (P&OM), Conductance Incremental (CI) and Modified Incremental Capacitance (CIM). Each of these methods is described below.



**II.1 CONSTANT CYCLICAL RATIO METHOD (Rcte)**

This is the simplest of the methods analyzed because there is no feedback or control. The cyclical ratio is adjusted only once and remains constant.

**II.2 CONSTANT VOLTAGE METHOD (Vcte)**

This technique is based on the premise that the maximum power voltage has an approximate linear relationship independent of the external factors. The voltage factor depends on the characteristics of the PV array used and is empirically calculated. The value falls between 0.7 and 0.8.

The method uses only one sensor. Figure 1 shows the algorithm presented in [9].

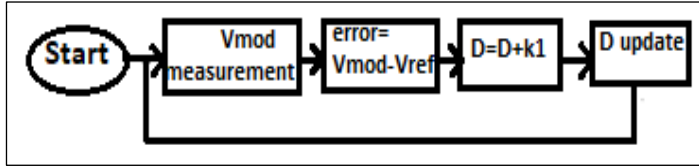

Figure 1: Algorithm for the constant-voltage method. Source: Authors, (2020).

**II.3 PERTURB & OBSERVE CLASSIC(P&OC)**

This technique is the most widely used due to its simple implementation. As the name suggests, the method involves

disturbing the voltage of the photovoltaic array in one direction and observing the output power. If the power increase, the disturbance continues in the same direction, otherwise the disturbance changes the direction as shown in Figure 2.

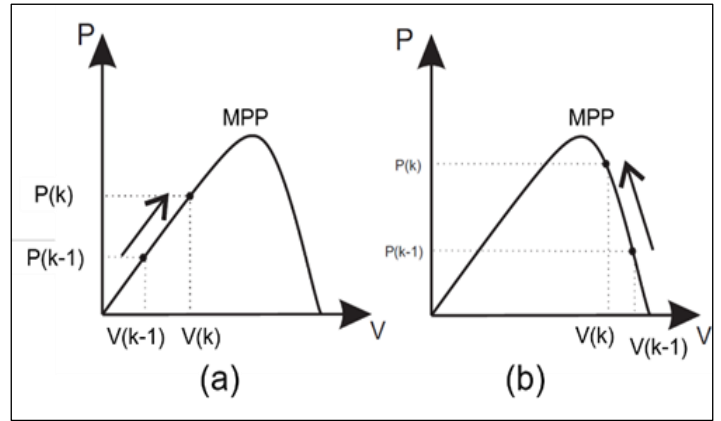

Figure 2: P&OC algorithm. (a) power increase, (b) Decrease power disturbance changes direction. Source: Authors, (2020).

As the process is continuously repeated, the maximum power point is never reached because the disturbance is always carried out, leaving the system oscillating next to it in a permanent regime. Figure 3 shows the flowchart of the method.

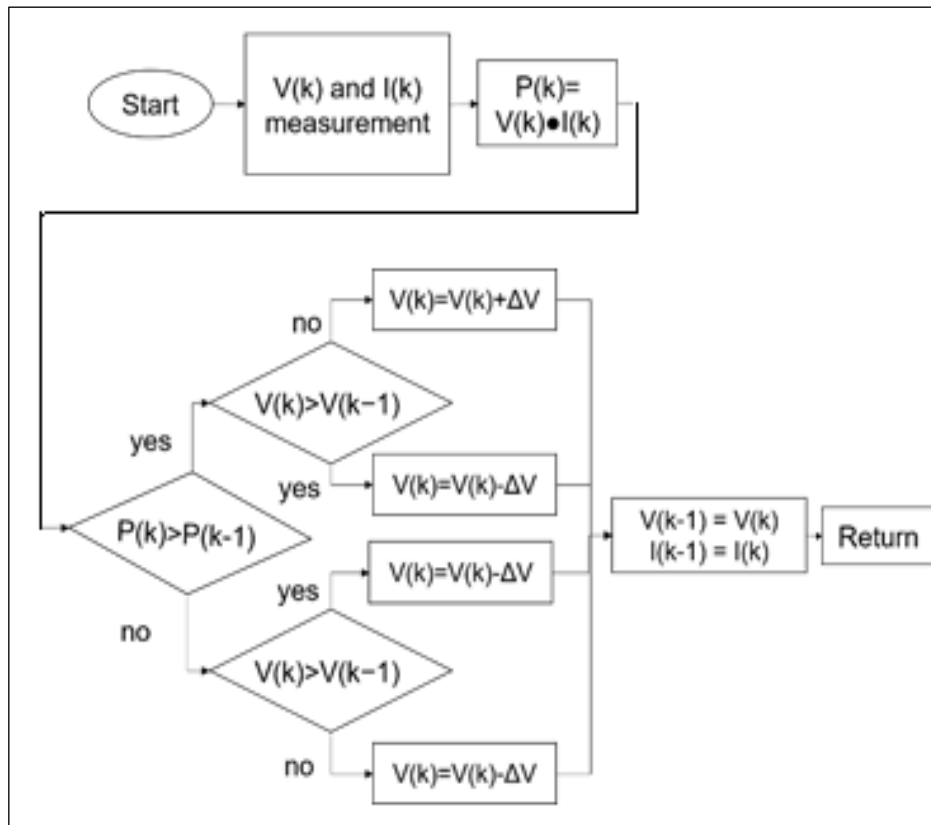

Figure 3: P&OC method flowchart. Source: Authors, (2020).

**II.4 PERTURB & OBSERVE WITH STOP CRITERION (P&OM) CLASSIC (P&OC)**

This method is similar to the previous one with a small modification, consisting in the implementation of a stopping

criterion in the algorithm; this is done to reduce the oscillations in a permanent regime. The flow chart of this method is shown in Figure 4.

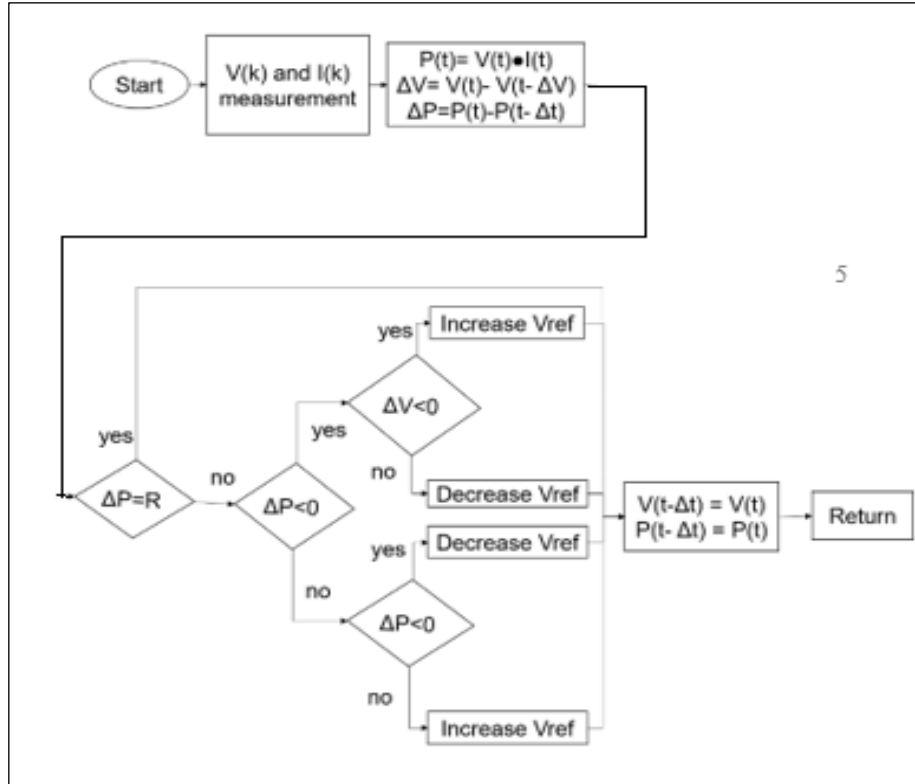

Figure 4: P&OM method flowchart.  
Source: Authors, (2020).

### II.5 INCREMENTAL CONDUCTANCE (IC)

The method is based on the instantaneous and incremental conductance values of the photovoltaic array. Current and voltage measurements are necessary, and through these, the power obtained by the voltage can be derived. Equation 1 can describe the method.

$$\frac{dP}{dV} = \frac{d(VI)}{dV} = I \frac{dV}{dV} + V \frac{dI}{dV} = I + V \frac{dI}{dV} \cong I + V \frac{\Delta I}{\Delta V} \quad (1)$$

Basically, there are three situations for incremental conductance on PV module:  $I + V \frac{\Delta I}{\Delta V} > 0$ , Figure 5 (a), the action is to increase the output voltage.  $I + V \frac{\Delta I}{\Delta V} = 0$ , Figure 5 (b), the action is to maintain the output voltage.  $I + V \frac{\Delta I}{\Delta V} < 0$ , Figure 5 (c), the action is to decrease the output voltage.

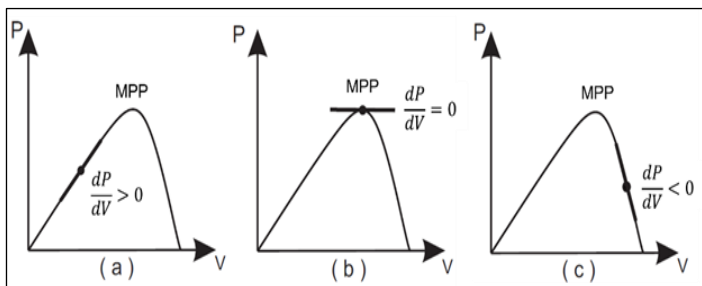

Figure 5: CI algorithm.  
Source: Authors, (2020).

If  $\Delta V$  is equal to zero, which can occur when there is variation in irradiation and not in temperature,  $\Delta I$  must be analyzed to determine the type of action to be taken. Figure 6 presents the flow chart of the Incremental Conductance method.

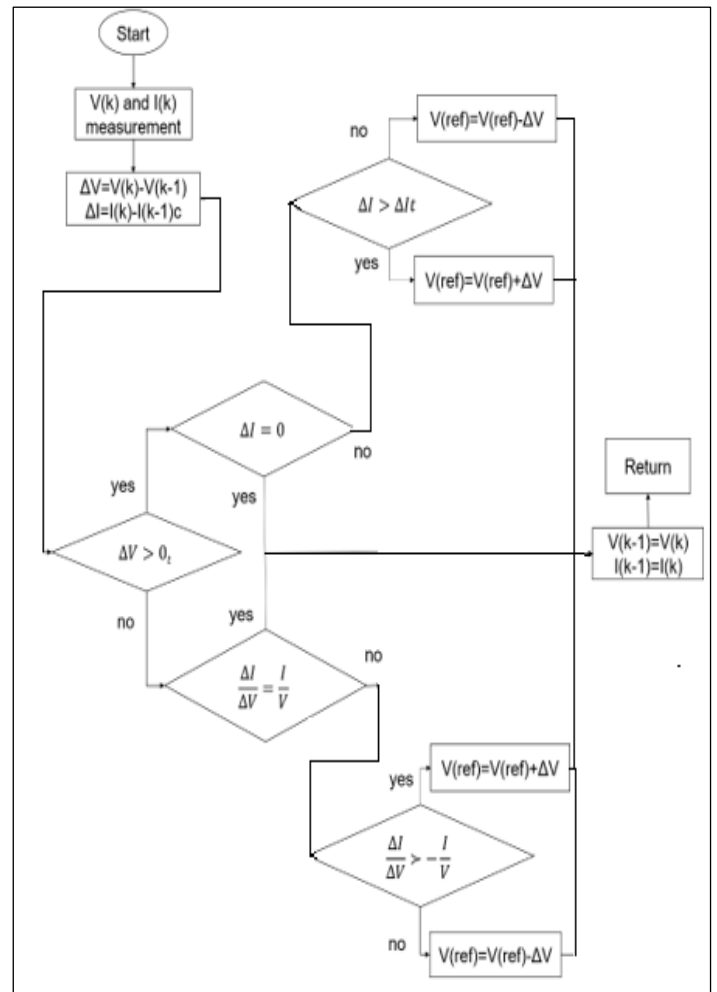

Figure 6: CI method flowchart.  
Source: Authors, (2020).

**II.6 MODIFIED INCREMENTAL CONDUCTANCE (CIM)**

This method takes into account the term that indicates that the system is in MPPT, that describes Equation 2:

$$\frac{I}{V} + \frac{dI}{dV} = 0 \tag{2}$$

In practice, this criterion will hardly be satisfied due to measurement errors, quantization errors, and discretization of the reference voltage. It is, therefore, necessary to define a tolerance range ( $\Delta\omega$ ) in which the situation can be considered correct. The flow chart in Figure7 presents the operation of this method [10].

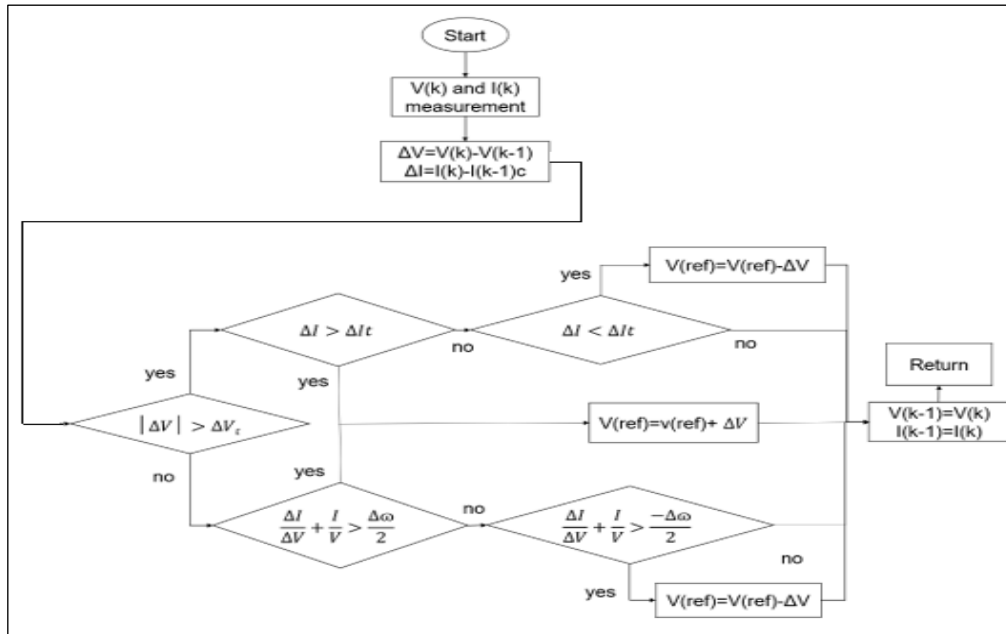

Figure 7: CIM method flowchart. Source: Authors, (2020).

**III. MATERIALS AND METHODS**

The simulation model used is a two-state inverter, as shown in the following Figure 8 (a). Where the objectives of the DC/AC inverter are: Synthesize the current to be injected into the electrical network and adjust the voltage of the DC bus ( $C_{DC}$  capacitor), while the DC/DC converter (Boost) has the objective of controlling the voltage in the PV terminals (Capacitor  $C_{PV}$ ). Considering the network as an infinite bus and the DC/AC inverter controlling capacitor voltage correctly, we can then represent the system as shown in Figure 8 (b).

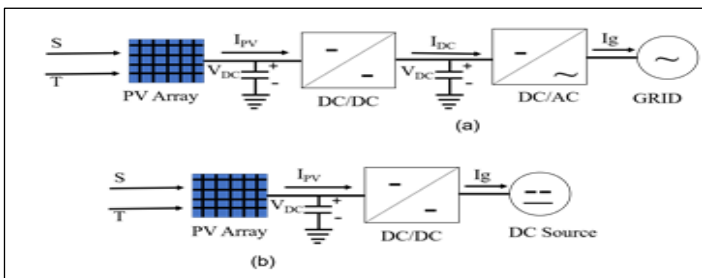

Figure 8: Diagram used for the simulation (a) and Simulated reduced diagram (b). Source: Authors, (2020).

Considering the network as an infinite bus and the DC/AC inverter controlling capacitor voltage correctly, we can then represent the system as shown in Figure 9.

**III.1 PHOTOVOLTAIC MODULE**

To research with photovoltaic modules, it is necessary to know first the operation and characteristics of the modules. Various

techniques for estimating parameters for photovoltaic modules were found in the literature. This article will use the technique presented by Xiao in [11]. This technique is based on the fact that the derivative of the power about the voltage in a photovoltaic module is zero at the maximum power point. Also, the influence of  $R_p$  (parallel resistance of the photovoltaic module circuit) is neglected. The flowchart used to determine the new parameters of the photovoltaic module in the condition of variations in temperature and irradiance is shown in Figure 9.

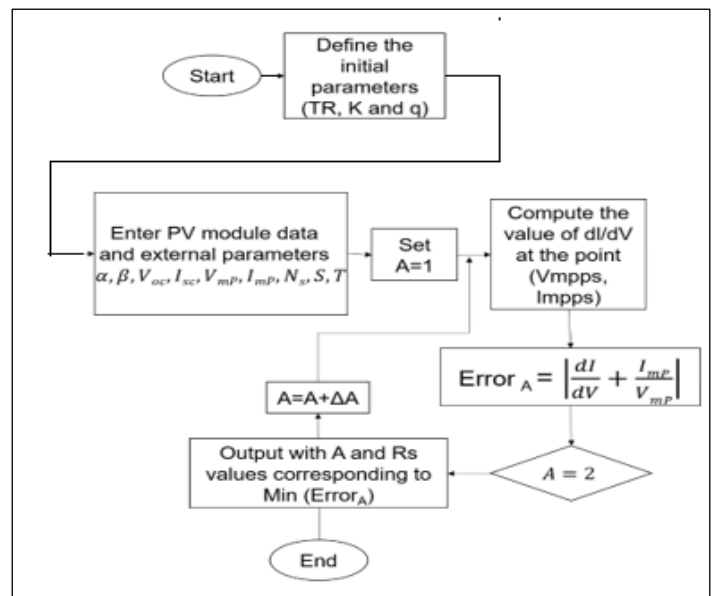

Figure 9: Flowchart of the technique used by Xiao for parameter estimation. Source: Authors, (2020).

**The variables are:**

$\alpha$ : Coefficient that relates the variation in the short circuit to that in the temperature,  $\beta$ : Temperature coefficient of  $V_{OC}$ ,  $V_{OC}$ : Open circuit tension,  $V_{SC}$ : Short-circuit current,  $V_{mpp}$ : Voltage at the maximum power point,  $N_s$ : Number of cell-associated in series in the PV module,  $S$ : Irradiance in  $W/m^2$ ,  $T$ : Temperature (K), Voltage converter.

The Boost converter used in the simulation shows the values that inductance and capacitors can take. Equations 3 to 6, are used to calculate the inductor and capacitor values of the Boost converter input [12].

$$L_{boost} = \frac{V_{in}D}{f_s \Delta I} \quad (3)$$

$$C_{in} = \frac{P_{in} D}{f_s V_{in} R_{ip} V} \quad (4)$$

$$D = \left(1 - \frac{V_{in}}{V_{out}}\right) \quad (5)$$

$$\Delta I = R_{ip} I_{admitted} \frac{P_{in}}{P_{out}} \quad (6)$$

Where Voltage volts [V], current amps [I], power Watts [P],  $R_{ip}$ : admitted ripple (voltage or current),  $D$ : cyclical ratio, capacitance Farad [C],  $L_{boost}$ : inductance Henry [H],  $f_s$ : switching frequency Hertz [Hz]. The subscripts *in* and *out* indicate the input and output values, respectively.

The calculated Parameters to consider for the designs of the inductor and capacitor of the boost converter are  $L$  ( $500 \times 10^{-6}$  H),  $C_{in}$  ( $400 \times 10^{-6}$  F) and  $f_s$  (10 kHz). It should be noted that the converter's control is applied to regulate the input voltage to it and not the output voltage as it usually happens. In this case and as explained above, the Boost converter's output capacitor is replaced by a DC voltage source since the voltage is regulated by a second DC/AC converter.

**IV. RESULTS AND DISCUSSIONS**

Figure 8 shows the PV system simulated in this article. The system consists of a PV array of the type (mSi460A8); it consists of the association of six modules in series. The output of the PV array is connected to a DC/DC Boost converter, which is associated with a three-phase inverter that keeps the output capacitor voltage constant. The data of the photovoltaic module used in the simulation have been taken from the NREL (National Renewable Energy Laboratory) database of standard test condition (STC) parameters are  $V_{OC_{STC}}$  (21.61 volts),  $I_{SC_{STC}}$  (5.012 amps),  $\alpha$  (0.06644),  $\beta$  (-0.32983) and  $N_s$  (36).

The simulation is performed, starting with the photovoltaic module under STC conditions of  $S=1000W/m^2$  and  $T=25^\circ C$ . To verify the MPPT algorithm's response and the control of the input voltage to the Boost converter, a variation in the irradiation of  $1000W/m^2$  is applied to  $500W/m^2$  at 0.3s and then after 0.6 s it is restored to the initial value. At the instant of time 0.9 s, an increase in temperature is applied, varying from 25 to  $40^\circ C$ .

The figures 10–15 show the responses to these variations in irradiation and temperature of each of the MPPTs analyzed. It is possible to verify that the irradiation and temperature variations result in changes in the modules' voltage to guarantee that the panel's power is maximum. Increasing irradiation increases voltage while increasing temperature results in a reduction in voltage. Also,

note that when the variations are applied, the algorithm finds the new point of maximum power transfer.

For the calculation of the cyclical ratio, equation (7) is used, considering six solar modules in series with a voltage of 180 V in the direct bus and an MPPT voltage of 17.31 V, the cyclical ratio can be calculated.

$$D = 1 - \frac{V_i}{V_o} = 1 - \frac{6 \cdot 17.31}{180} = 0.423 \quad (7)$$

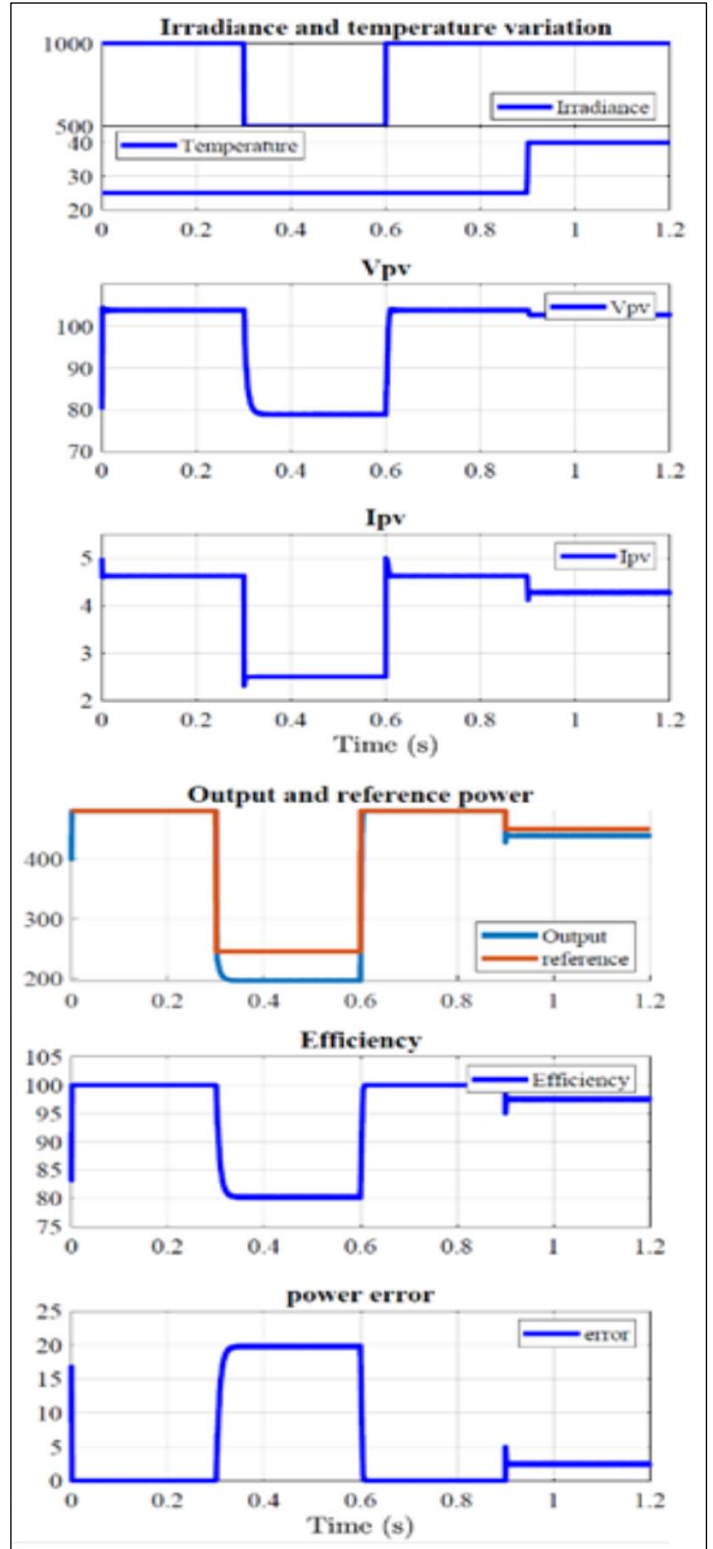

Figure 10: Simulation results of the constant cyclical ratio method.

Source: Authors, (2020).



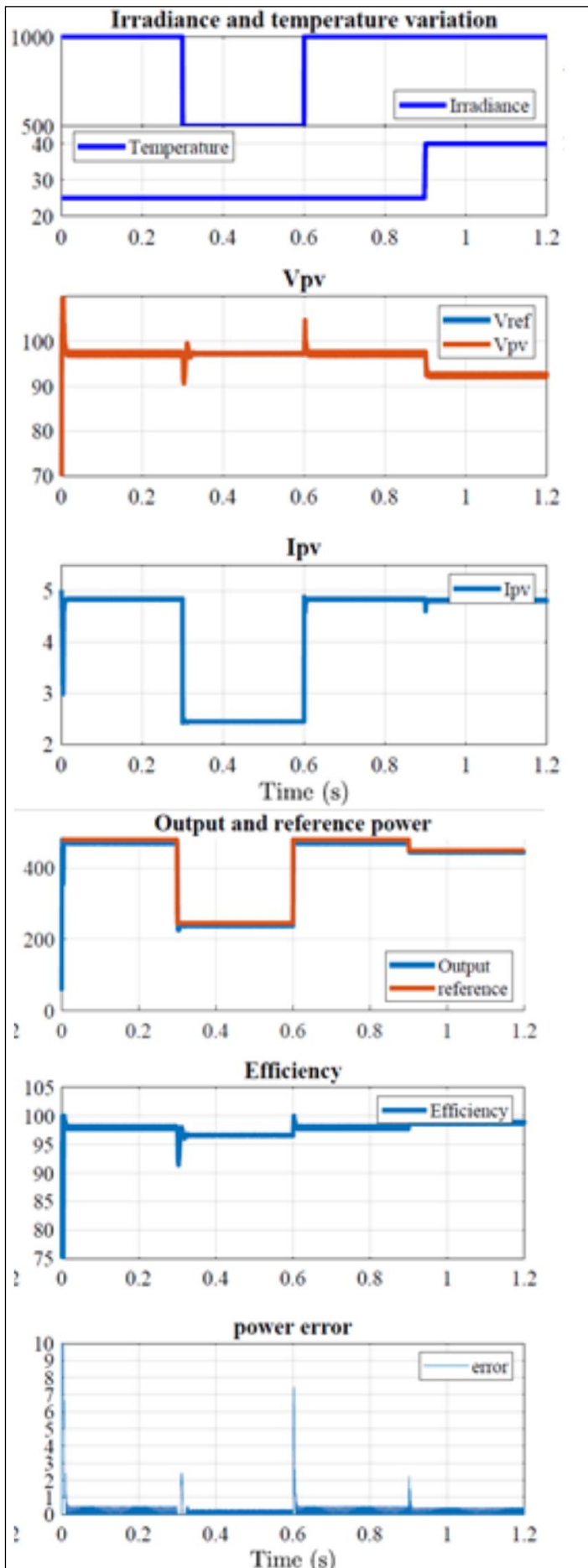

Figure 11: Simulation results of the constant-voltage technique. Source: Authors, (2020).

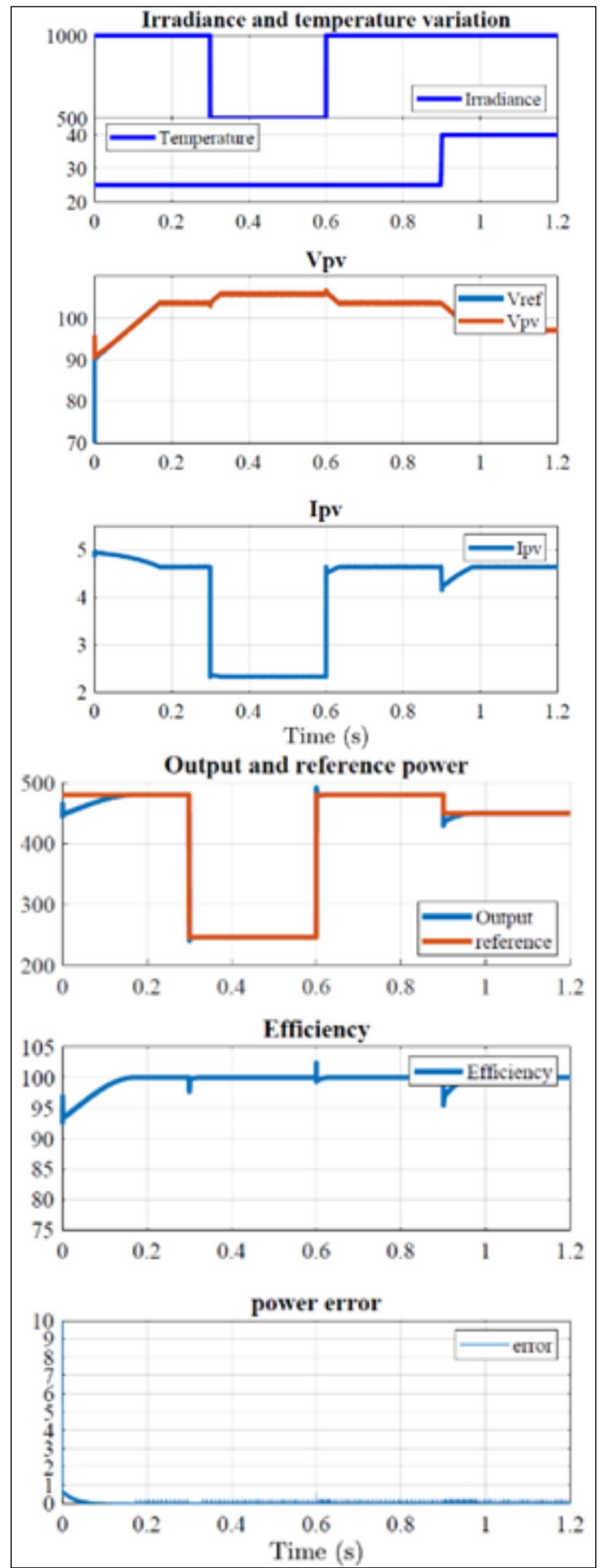

Figure 12: Simulation results of the CI technique. Source: Authors, (2020).

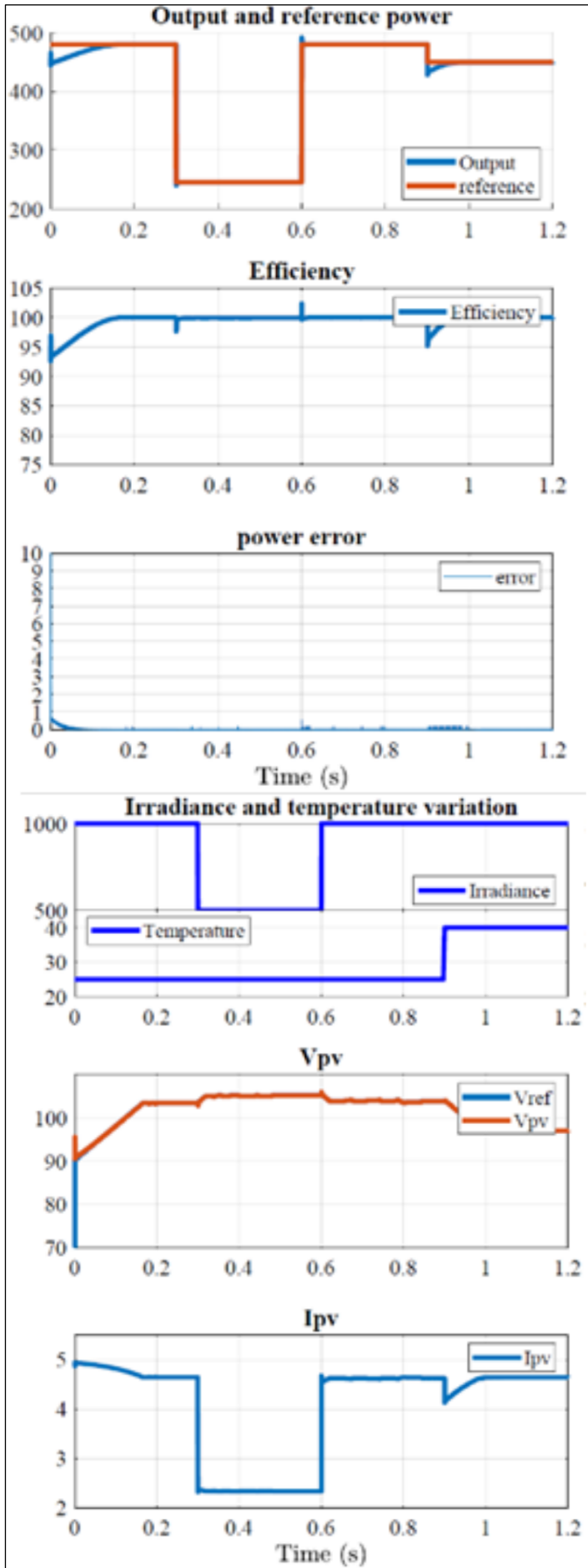

Figure 13: Simulation results of the CIM technique. Source: Authors, (2020).

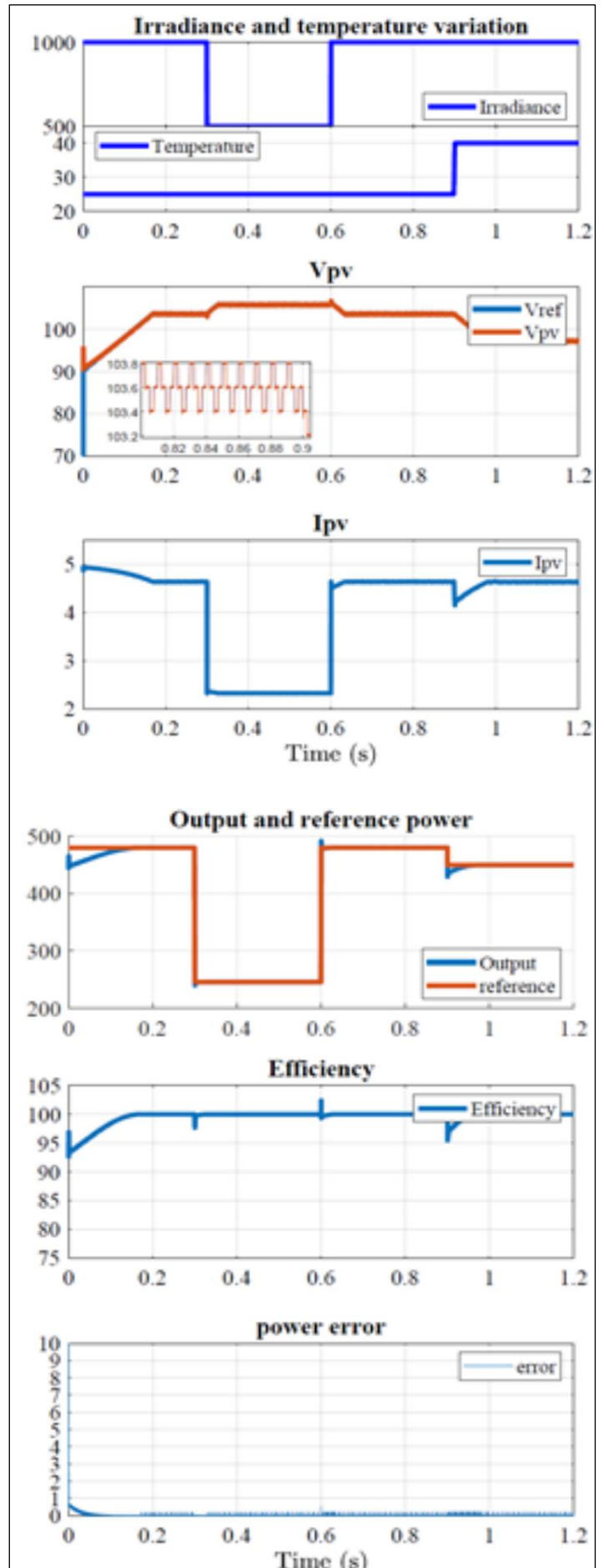

Figure 14: P&OC technique simulation results. Source: Authors, (2020).

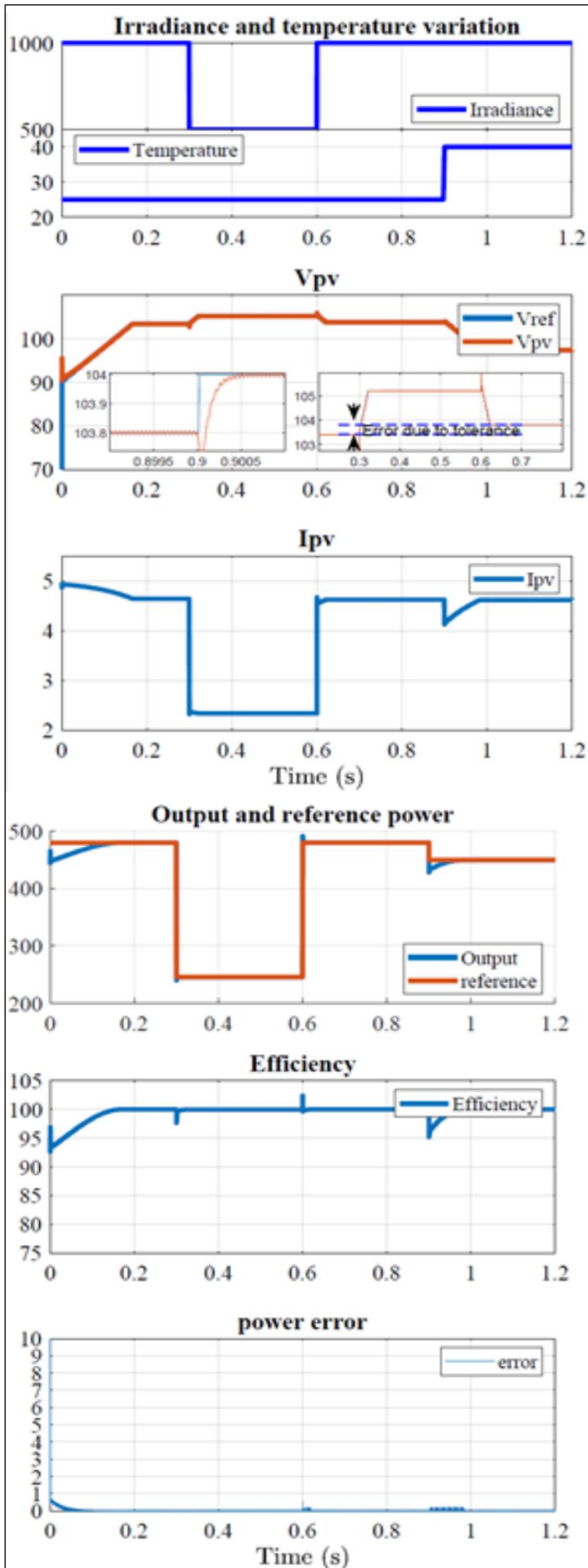

Figure 15: Simulation results of the P&OM technique. Source: Authors, (2020).

The zoomed-in view in Figure 15 shows the variation in the reference voltage around the MPPT voltage, which is one of the characteristics of this method. This variation is attributed to the lack of algorithm-stopping criterion when the MPP is reached. Finally, Table 1 presents the advantages and disadvantages of each method.

Table 1: Advantages and disadvantages of each MPPT method used.

MPPT Method	Advantages	Disadvantages
Constant Cycle Ratio	Low implementation complexity.	Have a high error in steady-state for conditions other than tuning. Cycle reason tuning is done offline.
Constant Voltage	Low implementation complexity. If a pilot cell is used, $V_{mp}$ tuning is done online.	If a pilot cell is not used, the reference voltage is tuned offline. If a pilot cell is used, it must be ensured that its operation is in the same condition as the other PV modules. Error in the steady state because $V_{mp} = 0.75$ is always considered.
Incremental Conductance	Online tuning. Low implementation complexity.	Has a slow response to rapid changes in the temperature and radiation. Oscillations in the steady state.
Modified Incremental Conductance	Online tuning. Low implementation complexity. Reduced oscillations.	Has a slow response to rapid changes in the temperature and irradiation. Error in steady-state.
Classic P&O	Online tuning. Low implementation complexity.	Slow response to rapid changes in the temperature and irradiation. Oscillations in steady-state.
P&OM	Online tuning. Low implementation complexity. Stopping criterion ends with steady-state oscillations, but this implies a small permanent error.	Has a slow response to rapid changes in the temperature and irradiation.

Source: Authors, (2020).

## V. CONCLUSIONS

The output power delivered by a photovoltaic field can be maximize using MPPT controls on the system. The use of six MPPT methods applied in MATLAB/Simulink already opens a range of viable options for the control of a photovoltaic system. As seen in the figures, the MPPTs have the desired functionality, keeping the voltage at the level where the power transfer is maximum. The information obtained in the qualitative comparison of behaviors and the accurate information explained were collected, concluding the advantages and disadvantages of each method, with the exception that each technique has its different application.

Note that all the techniques had similar behavior about environmental influences. Even with such a drastic variation in their temperature and irradiation values, the control was able to withstand climate disturbances, where it was concluded that the techniques have excellent reliability before abrupt environmental variations.

## VI. AUTHOR'S CONTRIBUTION

**Conceptualization:** Miguel Aybar, Yandi Gallego and Lesyani León.

**Methodology:** Miguel Aybar, Yandi Gallego and Lesyani León.

**Investigation:** Miguel Aybar, Yandi Gallego and Lesyani León.

**Discussion of results:** Miguel Aybar, Yandi Gallego and Lesyani León.

**Writing – Original Draft:** Miguel Aybar, Yandi Gallego and Lesyani León.

**Writing – Review and Editing:** Miguel Aybar, Yandi Gallego and Lesyani León.

**Resources:** Yandi Gallego and Lesyani León.

**Supervision:** Yandi Gallego and Lesyani León.

**Approval of the final text:** Miguel Aybar, Yandi Gallego and Lesyani León.

## VII. ACKNOWLEDGMENTS

This research was supported by FONDOCYT 2018-2019-3C1-160 (055-2019 INTEC) in the Dominican Republic.

## VIII. REFERENCES

- [1] R. Faranda, S. Leva, and V. Maugeri, "MPPT techniques for PV Systems: Energetic and cost comparison," in 2008 IEEE Power and Energy Society General Meeting - Conversion and Delivery of Electrical Energy in the 21st Century, 2008, pp. 1–6, doi: 10.1109/PES.2008.4596156.
- [2] M. A. Eltawil and Z. Zhao, "MPPT techniques for photovoltaic applications," *Renewable and Sustainable Energy Reviews*, vol. 25. Elsevier Ltd, pp. 793–813, 01-Sep-2013, doi: 10.1016/j.rser.2013.05.022.
- [3] M. Brito, L. Sampaio, G. Melo, and Canesin CA, "Contribuição ao estudo dos principais algoritmos de extração da máxima potência dos painéis fotovoltaicos," *Eletrônica De Potência*, vol. 17, no. 3, Aug. 2012, doi: <http://dx.doi.org/10.18618/REP.2012.3.592600>.
- [4] S. B. Kjær, "Evaluation of the 'Hill Climbing' and the 'Incremental Conductance' Maximum Power Point Trackers for Photovoltaic Power Systems," *IEEE Trans. Energy Convers.*, vol. 27, no. 4, pp. 922–929, 2012, doi: 10.1109/TEC.2012.2218816.
- [5] S. Oliveira da Silva, L. Campanhol, V. Bacon, and L. Sampaio, "Single-Phase Grid-Connected Photovoltaic System with Active Power Line Conditioning," *Eletrônica De Potência*, vol. 20, no. 1, pp. 1–11, Nov. 2015, doi: <http://dx.doi.org/10.18618/REP.2015.1.008018>.
- [6] L. Tang, W. Xu, and C. Mu, "Analysis for step-size optimisation on MPPT algorithm for photovoltaic systems," *IET Power Electron.*, vol. 10, no. 13, pp. 1647–1654, 2017, doi: 10.1049/iet-pel.2016.0981.
- [7] S. B. Jeyaprabha and A. I. Selvakumar, "Model-Based MPPT for Shaded and Mismatched Modules of Photovoltaic Farm," *IEEE Trans. Sustain. Energy*, vol. 8, no. 4, pp. 1763–1771, Oct. 2017, doi: 10.1109/TSTE.2017.2710302.
- [8] G. FILHO, R. A. P. FRANCO, and F. H. Vieira, "Algoritmo de Seguimento do Ponto de Máxima Potência para Sistemas Fotovoltaicos considerando Minimização de Erro e Derivada da Potência," *Tendencias em Matemática Apl. e Comput.*, vol. 21, pp. 157–170, Apr. 2020, doi: 10.5540/tema.2020.021.01.00157.
- [9] E. N. Chaves, J. H. Reis, E. A. A. Coelho, L. C. G. Freitas, J. B. V Junior, and L. C. Freitas, "Simulated Annealing - MPPT in Partially Shaded PV Systems," *IEEE Lat. Am. Trans.*, vol. 14, no. 1, pp. 235–241, 2016, doi: 10.1109/TLA.2016.7430084.
- [10] J. Lopez-Seguel, S. I. Seleme, P. Donoso-Garcia, L. F. Morais, P. Cortizo, and M. S. Mendes, "Comparison of MPPT approaches in autonomous photovoltaic energy supply system using DSP," in 2010 IEEE International Conference on Industrial Technology, 2010, pp. 1149–1154, doi: 10.1109/ICIT.2010.5472594.
- [11] Weidong Xiao, W. G. Dunford, and A. Capel, "A novel modeling method for photovoltaic cells," in 2004 IEEE 35th Annual Power Electronics *Specialists* Conference (IEEE Cat. No.04CH37551), 2004, vol. 3, pp. 1950–1956 Vol.3, doi: 10.1109/PESC.2004.1355416.
- [12] D. F. Zaians, A. J. Balbino, C. L. Baratieri, and A. L. Stankiewicz, "Comparative analysis of buck and boost converters applied to different maximum power point tracking techniques for photovoltaic systems," in 2017 Brazilian Power Electronics Conference (COBEP), 2017, pp. 1–6, doi: 10.1109/COBEP.2017.8257383.





ISSN ONLINE: 2447-0228



### RESEARCH ARTICLE

### OPEN ACCESS

## SCADA SYSTEM FOR CHEMICAL WATER TREATMENT PLANT OF THE THERMOELECTRIC POWER PLANT “JOSÉ MARTÍ”

Marcel Pérez Vazquez\*<sup>1</sup> and Roberto Luís Ballesteros Horta<sup>2</sup>

<sup>1,2</sup> University "Marta Abreu" of Las Villas - UCLV. Santa Clara, Cuba.

<sup>1</sup> <http://orcid.org/0000-0001-9046-5263> , <sup>2</sup> <http://orcid.org/0000-0002-4941-754X> 

Email: \*perezmarcel1994@gmail.com, rball@uclv.edu.cu

### ARTICLE INFO

#### Article History

Received: November 19<sup>th</sup>, 2020

Accepted: February 08<sup>th</sup>, 2021

Published: February 15<sup>th</sup>, 2021

#### Keywords:

Programmable Logic Controller, SCADA, Chemical Water Treatment Plant, Modbus.

### ABSTRACT

The monitoring and control of all industrial processes in today's society is an essential requirement to achieve efficient productivity. The main objective of the work is to design a SCADA system for the chemical water treatment plant of the Thermoelectric Power Plant “José Martí”. For this, the architecture and the SCADA were designed, the results and contributions obtained from the tests carried out were evaluated. In the work, the PLC M221CE24R was used, which has very good computational performance and an adequate cost/benefit ratio. The design was carried out using the Eros Cuban development platform, version 5.11, and the Modbus TCP/IP protocol was used for communication between the automaton and the Eros. The SCADA that was designed allows to know in real time the parameters and alarms of the plant and the same actions can be executed locally and remotely. For what is viable and necessary, because it guarantees technological independence. The simulation and the tests carried out, both in the laboratory and in situ, validate its functionality and it is designed in a scalable and flexible way to assimilate future extensions.



Copyright ©2016 by authors and Galileo Institute of Technology and Education of the Amazon (ITEGAM). This work is licensed under the Creative Commons Attribution International License (CC BY 4.0).

### I. INTRODUCTION

Today, the basis of electricity generation in Cuba is constituted by thermoelectric plants [1]. These plants are characterized by being of the steam type, since in these, the chemical energy of the fuel is transformed into heat energy, in order to produce steam in the boilers, then this is conducted to the turbine, where its kinetic energy is converted in mechanical energy, which is transmitted to the generator to produce electrical energy [2].

Said boiler-turbine-generator system also needs enormous amounts of water, which is added from an external source, to replace that which is lost in the boiler and the steam distribution system, which includes purges, steam leaks, losses of condensate and steam used directly in the processes. Thus, the efficiency with which steam boilers operate and consequently their operating cost, the safety of their operation and their durability, depends to a large extent on the quality of the water with which they are fed [3].

Therefore, this water requires a special quality, so its treatment is essential. The objective of this treatment is to prevent

possible corrosion and incrustation [4]. For this, chemical water treatment plants are installed in each of the CTEs with the aim of purifying and demineralizing it.

A large part of the causes of these deposits of salts and encrustations on the walls of the boiler tubes is due to the previous treatment that the feed water receives. According to studies [5], the electrical industry in Cuba is one of the largest consumers of energy carriers and other inputs such as water, therefore, the rational and efficient use of these resources is a matter of utmost importance. Thus, in recent years the country has worked successfully in the design and implementation of a policy of saving power plants.

Currently the status of the automatic in the Chemical Water Treatment Plant of the Thermoelectric Power Plant "José Martí" is not the best, the measurements of the main physical process variables that determine the quality of the water produced are performed at the laboratory level, therefore their monitoring and supervision is inefficient. There is no record of the magnitudes of the aforementioned physical variables evidenced by the non-existence of a PLC.

The operation of the water chemical treatment process is done manually. The foregoing evidences the non-existence of a SCADA system to carry out any of the aforementioned tasks or others that this application is capable of carrying out and that have an impact on a great improvement for the plant, such as alarms, graphs of the behavior of variables over time, records of these magnitudes for statistical and performance analysis, among others.

## II. MATERIALS AND METHODS

The elaboration of a SCADA system is the final stage of a study process of characterization and evaluation of the operating conditions of the different processes to automate, in conjunction with the client's and economic requirements. These systems can monitor and supervise from a control center, the processes of

distant remote stations, with the use of various types of communication links such as satellite systems, field buses, radiocommunications, cellular telephony, among others [6].

In the aforementioned plant it is of great interest to monitor the levels in each tank of demineralized water, raw water and filtered water, as well as the levels of the different water storage tanks and the levels of the soda and acid tanks.

Figure 1 shows the proposed general architecture of the system, in this figure it is observed that the first level or field level is made up of the entire network of sensors-transmitters and final action elements. The instrumentation has a standard 4-20mA output and they are acquired by the PLC through its analog input modules. The control level is the PLC M221CE24R. The last level or supervision level is the SCADA software Eros.

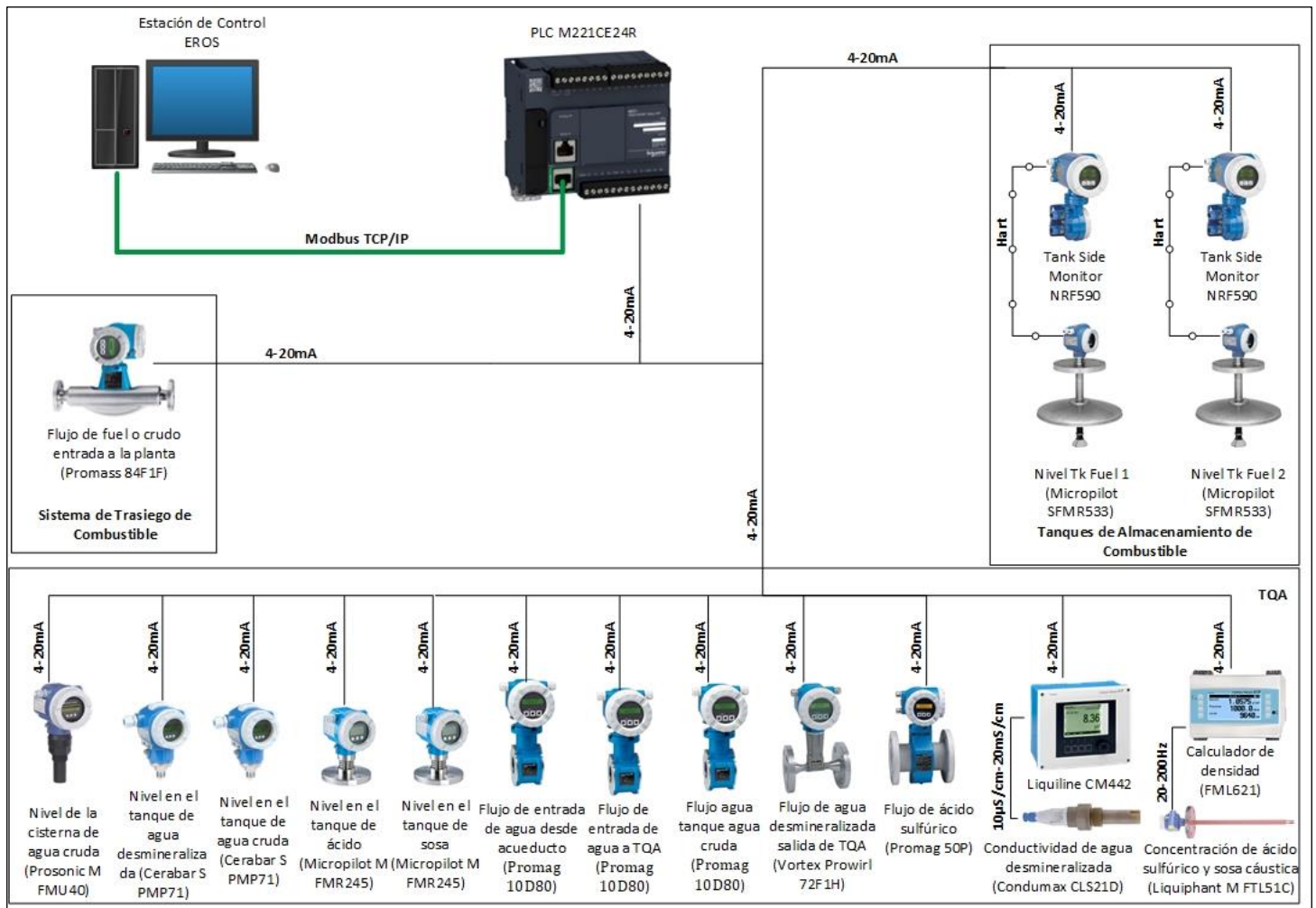

Figure 1: SCADA system architecture.

Source: Authors, (2020).

### II.1 PLC M221CE24R

The PLC used is Schneider Electric's Modicon M221CE24R (Figure 2), which is modular in structure. This device constitutes the core element of the system, as it collects all the signals from the field and acts on the final action elements. On the other hand, it is in charge of the primary processing of the information, the implementation of the control ties and the communication with the supervisory level [7].

For the configuration and programming of the PLC M221CE24R, the EcoStruxure Machine Expert Basic software was used, which supports the following IEC-61131-3 programming languages [8]:

- Ladder diagram language
- Instruction list language
- Grafset (List)
- Grafset (SFC)



Figure 2: PLC M221CE24R.  
Source: [7].

Figure 3 shows a fragment of the PLC M221CE24R programming related to the demineralized water production process.

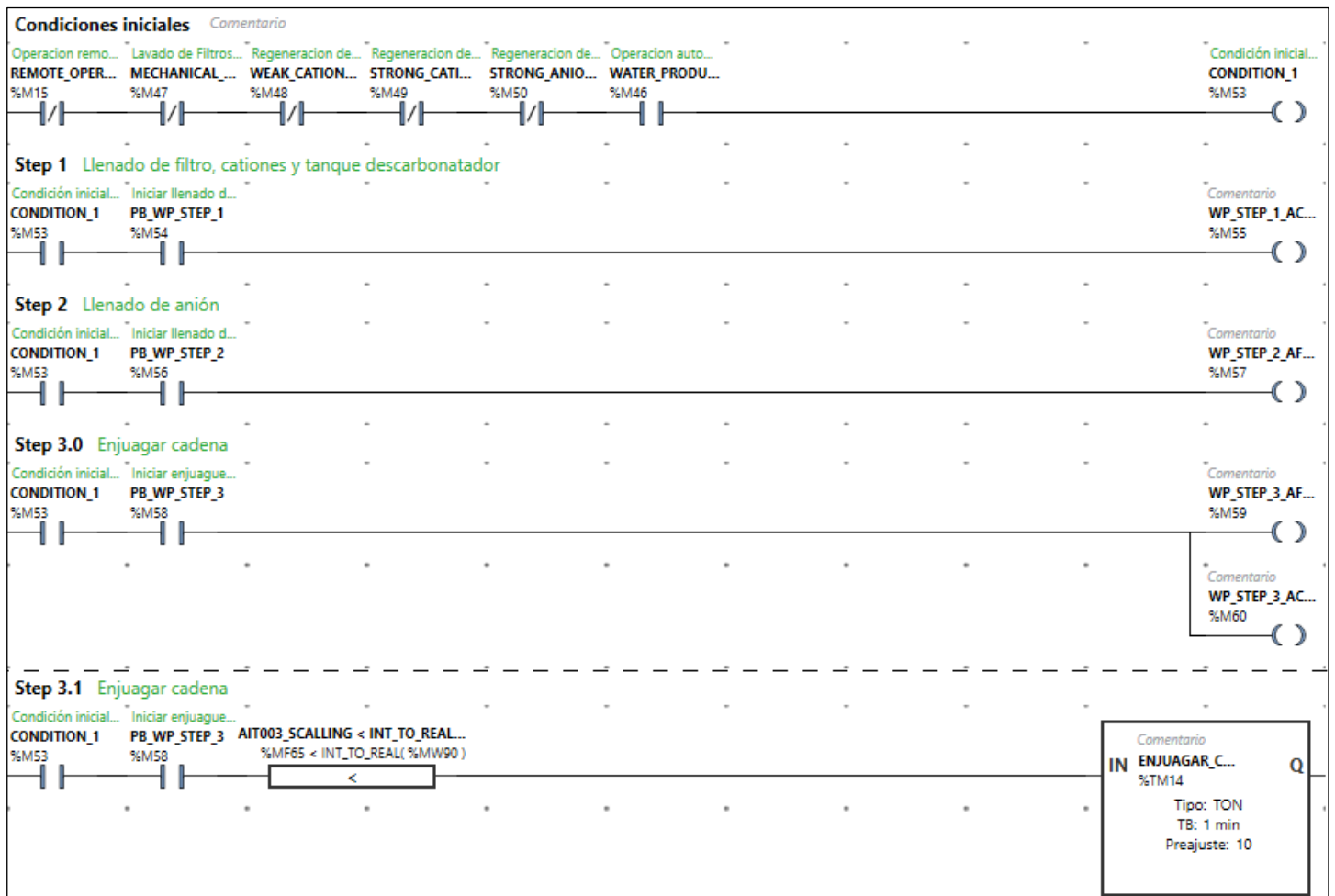

Figure 3: Fragment of the PLC M221CE24R programming using EcoStruxure Machine Expert Basic software.  
Source: Authors, (2020).

Modbus/TCP was introduced by Schneider Automation as a variant of the Modbus protocol family, widely used for the supervision and control of automation equipment. Specifically, the protocol defines the use of Modbus messages in an intranet or internet environment through the TCP/IP protocols. Figure 4 shows the configuration of the PLC's Ethernet network as Modbus TCP Server.

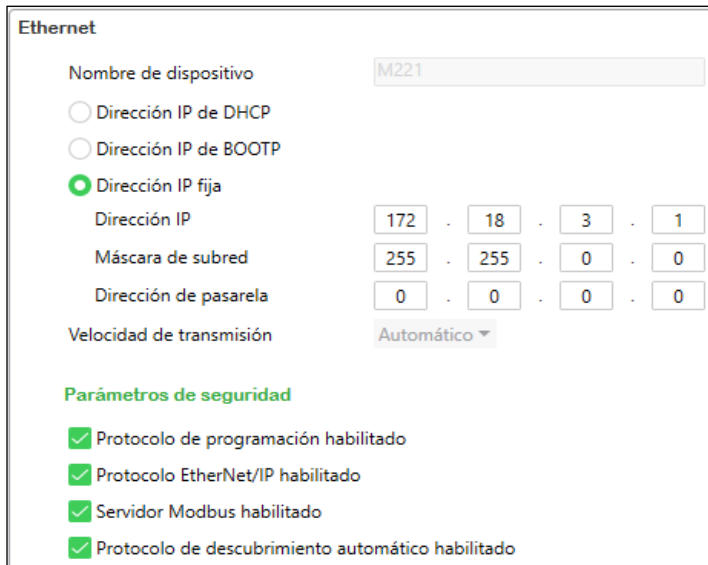

Figure 4: Configuration of the PLC's Ethernet network as Modbus TCP Server.

Source: Authors, (2020).

The communication parameters of the PLC's Ethernet network as Modbus TCP Server are:

**Programming protocol:** Allows you to enable or disable programming through the Ethernet port.

**Ethernet / IP protocol:** Allows you to enable or disable the Ethernet / IP protocol to connect to a network for data exchange.

**Modbus server:** Allows you to enable or disable the Modbus TCP server.

**Auto-discovery protocol:** Allows you to enable or disable the auto-discovery protocol to automatically discover devices on supported Ethernet field buses.

## II.2 EROS

Eros is the Process Supervision and Control System, developed for Windows operating systems, by the Automation Division of the Cuban Nickel Computing, Communications and Electronics Services Company (SERCONI). It contains the experience accumulated for more than 15 years and has been employed in various industrial sectors.

Eros has a programming environment that allows executing blocks of programs. These scripts, as they are also called, are executed within the system in each measurement cycle, to perform a certain task. This allows to substantially expand its possibilities, by being able to link in the scripts, variables and registers that are measured in different devices and even in different networks. For this purpose, there is a compiler with a high-level language similar to PASCAL, which converts the source code into an intermediate code, highly optimized and which is subsequently executed by a virtual machine designed for such purposes [9].

The Eros platform is a modern and modular system. It contains user-friendly interfaces and is packed with production-proven and reliable features. Eros advantageously competes with

other similar systems in terms of ease of configuration, always offering functionality by default; The parameterization is done hot, so it does not need, unlike other SCADAs, to stop the supervision process to make changes to the configuration [10].

Multiple industrial process measurement and control devices are connected to the SCADA Eros, such as PLCs, actuators, network analyzers, sensors, etc. from different providers which can be installed on a bus and operated through the MODBUS communication protocol. For this, Eros has a driver called MODBUS MASTER.

The communication parameters of the MODBUS MASTER driver are:

**COM:** Communications Port Number (COM), up to 255.

**Speed:** Speed with which it will communicate with the devices (Baudrate).

**Parity:** Checking the parity of the data (Even, Odd, No parity).

**Data length:** This can be 5.7 or 8 bits.

**Stop bits:** The stop bits of the character can be 1 or 2.

**Active:** Option to activate or deactivate the Port.

**Transmission Mode:** If the communication will be ASCII or RTU.

**Bus flow control:** When communication is through a bus, data flow control can be done by hardware.

**RTS values for transmission:** In the case of using software flow control.

In this case it was only necessary to disable the port as shown in Figure 5.



Figure 5: MODBUS MASTER configuration in Eros.

Source: Authors, (2020).

In addition to the driver's communication parameters, each of the devices that will be connected to the bus must be configured. When the Use modbus over Ethernet network option is checked, the screen shown in Figure 6 is displayed to set the parameters for this type of connection:

**Encapsulation of the network frame:**

- Modbus TCP: Basic configuration.
- Socket: In this case, the Modbus frame is not encapsulated, it is sent as it would be sent through a serial port.



**IP Address:** This will be the address of the device on the Ethernet network.

**Port:** Logical port of the Ethernet connection, by default the Modbus by standard uses 502.

**Timeout (ms):** It is the time to define the communication error (Time Out).

**Default values:** The values that Eros will define by default in the parameters explained above.

### III. RESULTS AND DISCUSSIONS

Once the mounting and starting up stages ended, the automation engineering service obtained satisfactory results.

The SCADA application has 3 main interfaces, the alarms interface and the history interface, easily accessed through a button navigation system or through the drop-down menu that includes Eros. From each interface it is possible to exercise both navigation routes.

The screen where the application starts is shown in figure 7. This interface allows the operator to monitor the general parameters of the system. The figure shows the synoptic dedicated to different signals of flow, level, concentration and conductivity of the plant, as well as the status of the pumps and compressors involved in the process; which includes a simplified and easy to understand schematic of the different threads. Hovering the cursor over an object or label displays a sign indicating the name of the variable or pump in question.

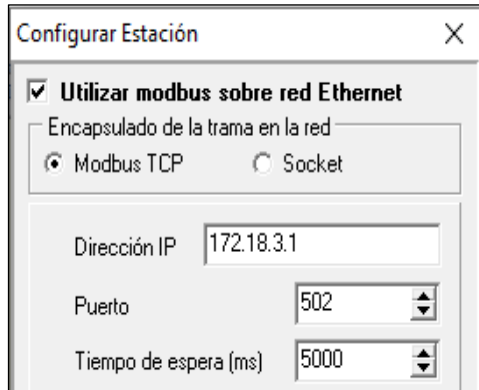

Figure 6: MODBUS MASTER device configuration in Eros.  
Source: Authors, (2020).

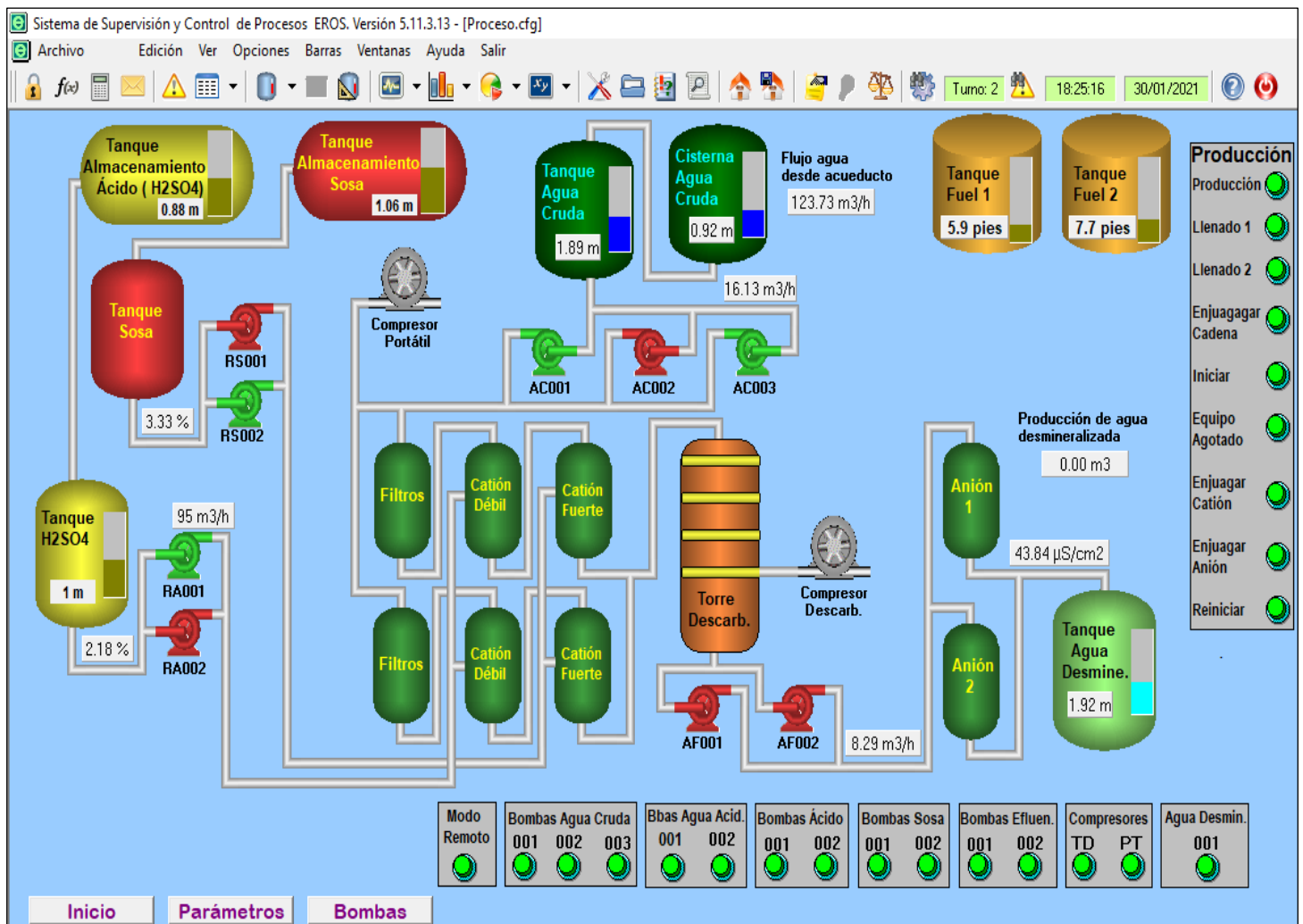

Figure 7: Process interface.  
Source: Authors, (2020).

The system parameters screen shown in Figure 8 is used so that operators can enter the parameters through which the plant will operate.

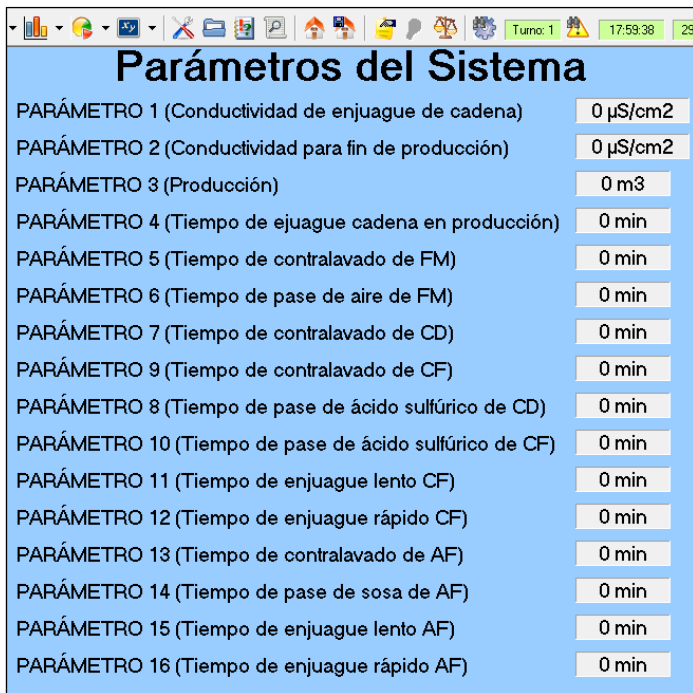

Figure 8: Parameters Interface.  
Source: Authors, (2020).

The motor working hours screen shown in Figure 9 is used to display the number of hours that each motor works in the time to be evaluated, it has buttons for resetting the working hours.

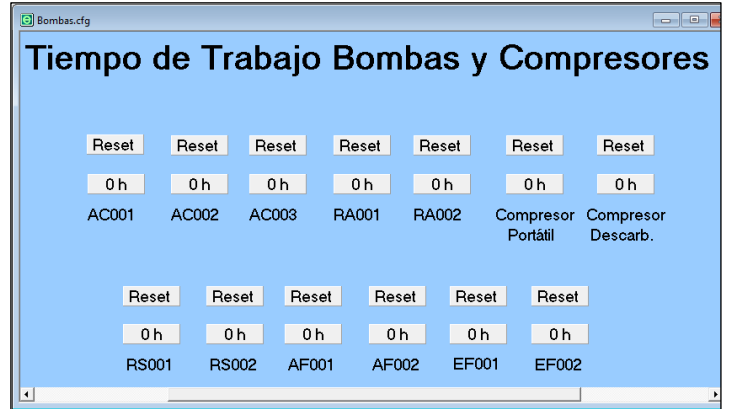

Figure 9: Pump and Compressor Work Time Interface.  
Source: Authors, (2020).

The alarms establish signals related to the appearance of anomalous situations or the acquisition of inoperative values in the variables; which generally implies intervention by the operator. From each screen of the supervisor it is possible to access the interface for alarms located in the form of a bar in the lower left part, so that the operator can easily notice and acknowledge it.

For analysis, the alarms are stored in a table containing the last 2000 generated by the system. In each column of the table, as shown in figure 10, the label or name, the value it acquires, the type, the start and end date in which they occur, as well as the start, end and recognition time are indicated. Each variable that is associated with an alarm includes two limits (upper and lower), both for operation and for prohibition, and some of them even define limits for checking alarms due to change.

Etiqueta	Valor	Tipo de Alarma	F.Inicio	H.Inicio	H.Fin	F. Fin	H. Reconocida
155- LIT007	0.00	< Rango Prohibitivo	29/01/2021	15:58:35	16:00:19	29/01/2021	
154- LIT006	0.00	< Rango Prohibitivo	29/01/2021	15:58:35	16:00:18	29/01/2021	
153- LIT005	0.00	< Rango Prohibitivo	29/01/2021	15:58:35	16:00:16	29/01/2021	
152- LIT004	0.00	< Rango Prohibitivo	29/01/2021	15:58:35	16:00:14	29/01/2021	
151- LIT003	0.00	< Rango Prohibitivo	29/01/2021	15:58:35	16:00:11	29/01/2021	
150- LIT007	0.00	< Rango Prohibitivo	28/01/2021	19:39:51	15:33:28	29/01/2021	
149- LIT006	0.00	< Rango Prohibitivo	28/01/2021	19:39:51	15:33:28	29/01/2021	
148- LIT005	0.00	< Rango Prohibitivo	28/01/2021	19:39:51	15:33:28	29/01/2021	
147- LIT004	0.00	< Rango Prohibitivo	28/01/2021	19:39:51	15:33:28	29/01/2021	
146- LIT003	0.00	< Rango Prohibitivo	28/01/2021	19:39:51	15:33:28	29/01/2021	
145- LIT003	0.00	< Rango Prohibitivo	27/09/2020	05:25:06	15:33:28	29/01/2021	05:25:11
144- LIT003	0.01	< Rango Prohibitivo	27/09/2020	05:16:06	15:33:28	29/01/2021	
143- LIT007	0.00	< Rango Prohibitivo	27/09/2020	05:14:04	15:33:28	29/01/2021	
142- LIT006	0.00	< Rango Prohibitivo	27/09/2020	05:14:04	15:33:28	29/01/2021	
141- LIT005	0.00	< Rango Prohibitivo	27/09/2020	05:14:04	15:33:28	29/01/2021	

Figure 10: Alarms interface.  
Source: Authors, (2020).

Trend graphs are the main means of grouping variables, to create informative diagrams for users. In this particular case, each variable represented in the graphs is stored in the historical ones; therefore, they can be analyzed in different periods of time, and

even statistical parameters associated with them can be calculated. For more organization, different groups of historical data were created according to the variables of the plant, as shown in figure 11.

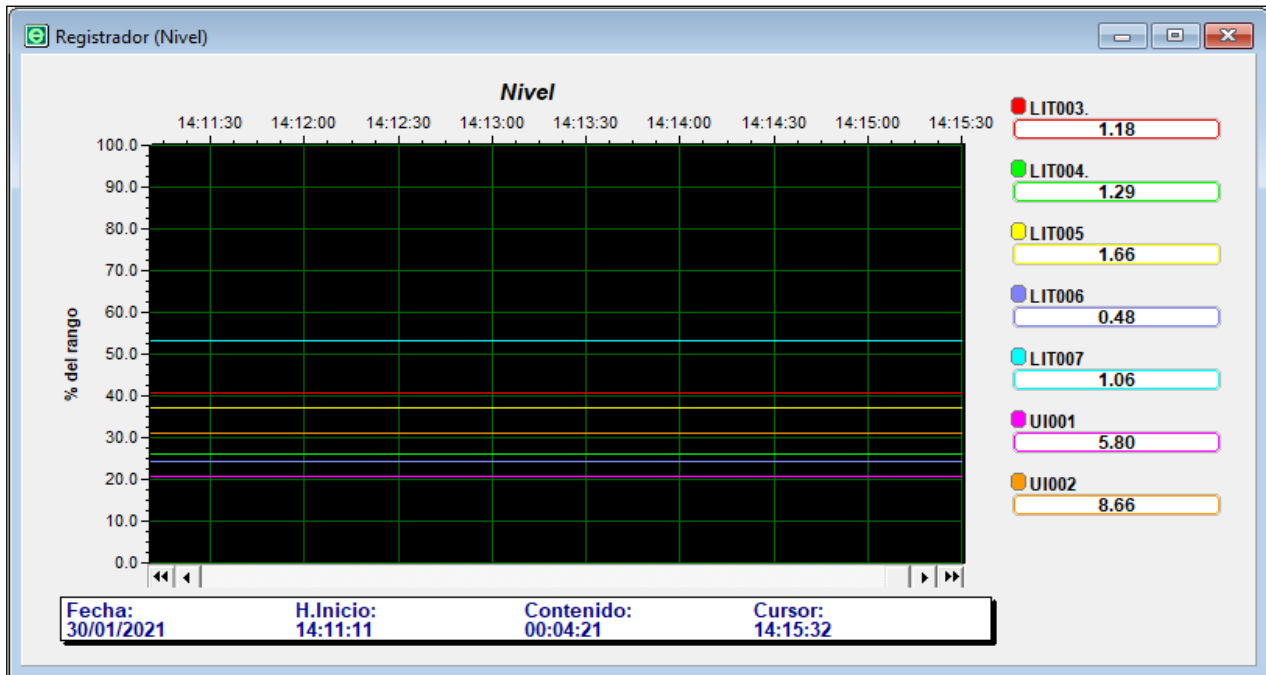

Figure 11: History Interface.  
Source: Authors, (2020).

Currently the SCADA system is in operation with very good results. The development of this work allows the systematization of knowledge about chemical water treatment plants and associated SCADA systems, which can be used for other works. A fully operational SCADA system is obtained and easily assimilated by the company's operators and technicians. With the execution of the project, the problems related to the acquisition of highly complex and valuable software are resolved. This is due to a decrease in raw materials and an increase in the quality of the final product.

#### IV. CONCLUSIONS

The SCADA system designed for the supervision of the chemical water treatment plant of the thermoelectric power plant "José Martí" is viable and necessary, since nowadays new technological solutions are created that allow a better use, rational use and saving of supplies. The use of protocols such as Modbus, offer high reliability in communication, as well as considerable time savings in configuration. The choice of the Eros platform constitutes a technologically and economically feasible solution, which allows integrating the diversity of existing technologies and equipment. The tests made to the SCADA system, both in the laboratory and in situ, guarantee the validity and functionality of the designs created. Likewise, it is a strength of this system to be designed in a scalable and flexible way to assimilate future extensions.

#### V. AUTHOR'S CONTRIBUTION

**Conceptualization:** Roberto Luís Ballesteros Horta.  
**Methodology:** Roberto Luís Ballesteros Horta.  
**Investigation:** Marcel Pérez Vazquez.  
**Discussion of results:** Marcel Pérez Vazquez.  
**Writing – Original Draft:** Marcel Pérez Vazquez.

**Writing – Review and Editing:** Marcel Pérez Vazquez and Roberto Luís Ballesteros Horta.  
**Resources:** Marcel Pérez Vazquez.  
**Supervision:** Roberto Luís Ballesteros Horta.  
**Approval of the final text:** Roberto Luís Ballesteros Horta.

#### VI. REFERENCES

- [1] H. Mora. "Las energías renovables y la mitigación del cambio climático en Cuba". CUBAENERGIA, 2013.
- [2] J. R. Romero, "Estudio Descriptivo y Analítico de una Planta de Ciclo Combinado". Facultad de Ingeniería Mecánica Eléctrica, Universidad Veracruzana, Xalapa, México, 2011.
- [3] Colectivo de Autores. "Tratamiento de agua para su utilización em calderas". Comisión Nacional para el Ahorro de Energía, Cuba, 2008.
- [4] G. Castillo. "Producción de agua desmineralizada para uso industrial". TECNOAQUA, diciembre 2013.
- [5] E. Madruga. "Revolución y energía". Revista CUBASOLAR, 2012.
- [6] Penín, A.R. "Sistemas SCADA" [Online]. Ciudad México, México. Available: <<https://books.google.com/cu/books?hl=es&id=32kCNG34TwC>>. Accessed 22 September 2020.
- [7] Schneider Electric. "Modicon M221 logic controllers. For hardwired architectures". Head Office. France, 2019.
- [8] Schneider Electric EcoStruxure Machine Expert - Basic. Operating Guide. Head Office. France, 2020.
- [9] Grupo-Eros. Manual del Usuario, Sistema de Supervisión y Control de Procesos Eros V5.11. SERCONI. Holguín, Cuba, 2019.
- [10] Grupo-Eros. Productos para la automatización. Folleto. Holguín, Cuba, 2016.



ISSN ONLINE: 2447-0228

## ITEGAM-JETIA

Manaus, v.7 n.27, p. 20-40. Jan/Feb, 2021  
DOI: <https://doi.org/10.5935/jetia.v7i27.713>



RESEARCH ARTICLE

OPEN ACCESS

## ROAD SAFETY STATUS AND SOME INITIATIVES IN NEPAL

Krishna Nath Ojha\*<sup>1</sup>

<sup>1</sup> Ministry of Physical Infrastructure and Transport. Kathmandu, Bagmati, Nepal.

<sup>1</sup> <http://orcid.org/0000-0003-4703-4825> 

Email: \*knojha256@gmail.com

### ARTICLE INFO

#### Article History

Received: October 27<sup>th</sup>, 2020

Accepted: February 04<sup>th</sup>, 2021

Published: February 15<sup>th</sup>, 2021

#### Keywords:

Highways,  
Traffic Safety,  
Road Traffic Accidents,  
Road fatality,  
Law enforcement.

### ABSTRACT

Global number of deaths due to road accident recorded is 1.35 million people each year and became the 8<sup>th</sup> leading cause of death globally and 3 times higher deaths rate in low income than in high income countries. Also 1<sup>st</sup> cause of death among children aged 5-14 and among young adults aged 15-29 with an average rate of 27.5 deaths per 100,000 populations and in every 24 seconds someone dies on the road. Nepal recorded 13,366 road-traffic accidents in the fiscal year 2018/19 resulting 2,789 fatalities, 4376 serious injuries and 10,360 minor injuries. Road Safety became a critical theme and number of deaths on the roads remains unacceptably high. Road Traffic Accident (RTA) related fatalities and injuries continue to be an important morbidity and mortality problem. Human factors, Road conditions, Vehicle conditions became the major causes of road crashes. Within SASEC countries, the accident rate is in increasing trend except a little improvement in Maldives. Education, Engineering and Enforcement are the major sectors to reduce the rate of accident. With due priority we should focus on them and for this several activities/action plan need to be implemented by allocating sufficient dedicated budget on road safety and strict implementation of road safety legislations/activities. The government policy in Nepal for transportation sector is to develop a self-sustainable, reliable, economic and safe transportation system for the social and economic advancement of the country. The road safety strategy is Safe road-infrastructures and services backed with effective post-crash response and conducive environment resulting in little or no casualties from the Road Traffic Accidents (RTAs). In a country where the annual loss due to road crashes is US\$ 55 million approx. improvement of safety standards on its roads should be highly prioritized. Nepal has committed to reduce road fatality by 50% in a decade. Instead the rate was found to be accelerating. The rate has not flattened even after the country renewed the commitment by adopting SDG Goal 3.6 of achieving 50% reduction in road fatality by 2020. Following declaration of Global Action Plan for the Decade on Road Safety, Nepal drafted a Road Safety Action Plan 2013/20 to mobilize efforts of relevant agencies in reducing crashes and is being updated. Considering the death data 2789 in 2018/19, we have to reduce about 2000 fatality from road crashes to achieve the 50% reduction target. So, in Nepal it is urgent to carry out enormous actions on all the five pillars of the Decade Action Plan to achieve the targeted reduction in road fatalities and SDG goals in road safety sector. Substantial improvements of expected number of accidents are to be quantified when the road section parameters improved and up keeping the city's infrastructure is important in reducing accidents as well as the severity level of the accidents that do occur. Attention to the inclusion of dedicated lanes that separate slow moving vehicles and high-speed vehicles and from pedestrians will have a positive effect on the frequency and severity of vehicle related collisions. The first horizontal curve after a long tangent may be the most critical curve and the risk will be 1.5 times greater than that of the tangent section and accident frequencies reduced due to improvement in land and shoulder width. A reduction in overloaded trucks is also conducive to a reduction in crashes.



Copyright ©2016 by authors and Galileo Institute of Technology and Education of the Amazon (ITEGAM). This work is licensed under the Creative Commons Attribution International License (CC BY 4.0).



## I. INTRODUCTION

### I.1 IN GLOBAL CONTEXT

Road Safety is a critical theme and number of deaths on the world's roads remains unacceptably high, with an estimated 1.35 million people dying each year. Road accident became the 8<sup>th</sup> leading cause of death globally and 3 times higher deaths rate in low income than in high income countries. 1<sup>st</sup> cause of death among children aged 5-14 and among young adults aged 15-29. With an average rate of 27.5 deaths per 100,000 populations, the risk of a road traffic death is more than three times higher in low-income countries than in high-income countries where the average rate is 8.3 deaths per 100,000 populations. Low-income countries 1% vehicles of worlds vehicles but 13 % of all death. high-income

countries bears 40% of the world's vehicles but 7 % of all death. Low- and middle-income countries bear a disproportionate burden of road traffic deaths. 54% of deaths are pedestrians, cyclists and motorcyclists and every 24 seconds someone dies on the road. Road traffic deaths decreased in 48 countries, Road traffic deaths increased in 104 countries, Road traffic deaths remained the same in 23 countries. No low-income country has reduced the number of road traffic deaths, Road traffic deaths have decreased in 23 middle-income countries and 25 High-income countries have decreased the number of road traffic deaths. The report suggests that the price paid for mobility is too high, especially because proven measures exist. Drastic action is needed to put these measures in place to meet any future global target that might be set and save lives [1-2].

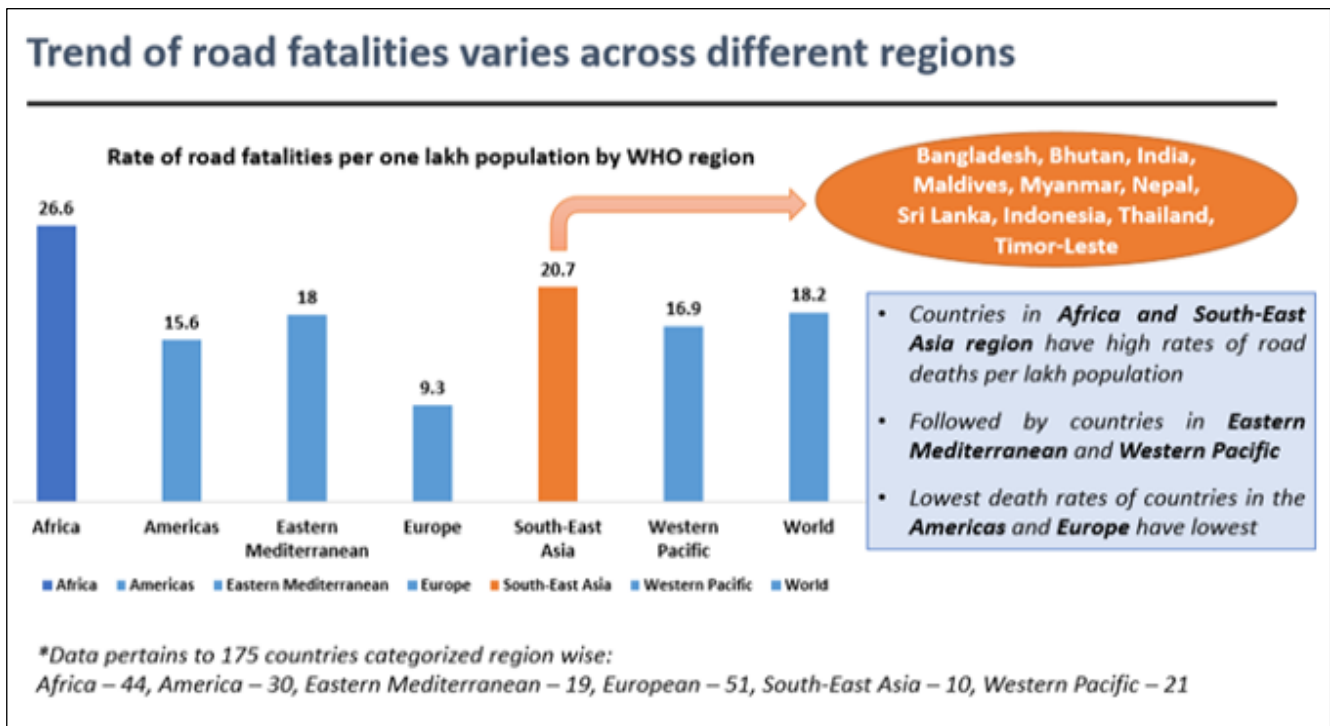

Figure 1: Rate of road fatalities per 0.1 million population by WHO region.  
Source: [1-2].

### I.2 IN GLOBAL CONTEXT

As per the Nepal police statistics, there were 13,366 road-traffic accidents in the fiscal year 2018/19 resulting 2,789 fatalities, 4376 serious injuries and 10,360 minor injuries [3]. However, these figures may not truly reflect the actual number of casualties occurring in Nepal as past researches have indicated that RTAs are under-reported, particularly, the minor injuries. Comparing the road traffic fatalities with the cumulative number of vehicles registered in the country up to 2018/19 (i.e. 3,503,077) [4], Nepal's fatality rate in this fiscal year was 7.96 per 10,000 registered vehicles and 9.84 per 100,000 populations, which, is still the higher rate in both Asia and the world. The fatality rate is actually higher than 7.96 if the number of vehicles phased out or scrapped and under-reporting are taken into consideration. Safety Issues in Nepalese hill roads (which form a substantial portion of the road network) are poor visibility at blind corners; poor shoulders; unforgiving side-drains, inadequate safety barriers at steep vertical drops; unscientific location of passing bays in single lane roads; lack of climbing lanes; very steep gradients at numerous sections,

narrow sections at built-up areas, etc. Along the roads in the plains (Terai), unforgiving drains, inadequate pedestrian provisions, inadequate delineation at bridge/culvert crossings, narrow carriageway at build-up areas, etc., are the predominant safety issues.

Decade of Action on road safety has been endorsed by the UNRSC and a wide range of public figures. As a result, the UNRSC released the Global Plan for the Decade of Action for road-safety 2011 to 2020 in May 2011. Nepal is also a signatory on the decade action plan for road-safety 2011 to 2020 and drafted the Nepal Road Safety Action Plan 3013-2020. The UN Global Action mandates member countries to develop their individual national plans for the decade (2011 to 2020) incorporating interventions under the following five pillars to road-safety [5].

1. Road safety management:
2. Safer roads and mobility:
3. Safer vehicles:
4. Safer road users:
5. Post-crash response:

## II. THEORETICAL REFERENCE

### II.1 ROAD TRAFFIC ACCIDENTS IN GHANA

Road Traffic Accident (RTA) related fatalities and injuries continue to be an important morbidity and mortality problem, as well as a health finance problem in Ghana requiring urgent attention and containment as has been done in some countries with developed economies. The problem of RTAs' in Ghana though must not be seen and managed through the lens of "RTAs' are just a safety issue", and hence being tackled as such; as has been reflected in the public domain in the past. The problem of RTA containment should primarily focus on prevention by utilizing a multifaceted public health approach. This approach draws on all the relevant public health disciplines of epidemiology, statistics, environmental sciences, behavioral sciences, safety and injury prevention, health services administration and others, as well as the incorporation of emergency and advanced trauma support services, to guide and formulate policies towards containing the scourge of the RTA problem currently confronting the country. The problem of RTAs in Ghana is not typical of Ghana only, but a problem in the sub-region and Sub-Saharan Africa in general. The urgency for containment of the RTA situation in Ghana (and the Sub-Saharan region) is especially important now; more so as the United Nations considers the problem of RTA containment a global public health priority, and has declared the decade 2011 to 2020 as the "decade of action for road safety" [6].

### II.2 ROAD TRAFFIC CRASH DATA SOURCES, PROBLEMS, AND COLLECTION

Road traffic crash data are useful tools to support highway safety programs that tend to reduce road traffic crashes. They can be used by many authorities such as: law enforcements to identify persons at fault in road traffic crashes; insurers seeking facts about traffic crash claims; road safety researchers to access crash reliable database; decision makers to develop long-term, statewide strategic plans for traffic and highway safety; and highway safety administrators to help educate the public. Given such trends, study showed that a general overview of the sources, collection methods, and problems associated with crash data to better gaining an understanding of road traffic operational problems, locating hazardous road sections, identifying risk factors, developing accurate diagnosis and remedial measures, and evaluating the effectiveness of road safety programs [7].

#### II.2.1 Causal Exploration of Bike Accidents in the Bay Area

Accidents that occurred closest to an intersection would be more likely to end in injury or fatality. In general, the distance from an intersection was not found to be a significant factor in predicting the severity of a bicycle-related accident. The relative risk for injury in a bicycle-related accident was 27.5% higher when the accident occurred due to the fault of the driver. The relative risk for injury in a bicycle-related accident where the pedestrian was at fault was much higher than when the bicyclist was at fault. A cyclist involved in a solo accident, such as one where a pothole or crack in the road causes the accident, is roughly five times more likely to suffer an injury relative to an accident where the cyclist is clearly at fault. This suggests that upkeep of the city's infrastructure is important in reducing accidents as well as the severity level of the accidents that do occur. On the other hand, solo accidents, which are likely to end in injury, are very unlikely to end in a fatality for the cyclist involved. When the accident took place in an area where it was dark outside but the streetlight was not

functioning, the relative probability of the accident ending in an injury was much higher. This is another area that is easy to improve on. The risk of an accident resulting in an injury at night with the street light functioning was almost the same as the risk of an accident resulting in an injury during the daytime. This result suggests that perhaps commuting at night is not as dangerous as commuting during the day-time. A wet road surface did not have a significant result on the risk of an accident resulting in an injury. This may have to do with the fact that cyclists are not often found riding their bikes outside during inclement weather. However, a slippery road surface contributed to a higher relative risk of injury in a bike-related accident, compared to a dry road surface. The risk of fatality was not significantly affected by the condition of the road surface. While one can look at all the numbers and make inferences on what causes an accident and what contributes to its severity, the most important thing to consider is that a good amount of these accidents can be prevented. Better bicycle education and training can keep a cyclist from making mistakes that may put him or her in conflict with a pedestrian, parked car, or moving vehicle. Likewise, if an automobile driver has respect for the cyclist, they are sharing the road with the occurrence of these accidents resulting in an injury can be reduced. Additionally, continued attention to the inclusion of bike lanes that separate cyclists from drivers and pedestrians will have a positive effect on the frequency and severity of bicycle-related collisions [8].

#### II.2.2 Road Traffic Accidents (RTAs) Trends on Kathmandu-Bhaktapur

There is an increase in accident immediately after completion of the widening of road and decrease in the successive years. This is because of unfamiliarity among drivers with the increased design speed and unchanged behavior of pedestrians. The rate of accident is decreasing after passage of sometime as a result of awareness program conducted by the project office and media partners focusing safety of school children, bike riders, drivers and pedestrians. Main contributing factors of road accidents are: carelessness, over speeding, defective vehicle, drink driving and overtaking. Age is another major cause of accidents; 25 - 34 years' age group is found to be the vulnerable group (41%). Accidents corresponding afternoon hours (12:00-15:59) are the highest (35%). Motorbikes major mode of transportation is involved in accidents (45.5%). The reason being motorcycles consists of more than half number of total vehicles plying in this section and major violation of traffic rule being made by them. Males' involvement in road accidents is higher than females corresponds to the higher males who are involvement in outdoor works along with their more aggressive nature. Following recommendations are made to ensure the traffic safety along the Kathmandu-Bhaktapur road [9].

1. Stringent enforcement of the provisions of the VTMA for traffic rule violators. Continue and promote drunken driving testing drive.
2. Priorities for behavioral changes by immediate actions such as road campaigns and visual demonstrations. Conduct awareness and training program for drivers to raise the level of understanding and skills.
3. Installation of traffic signs in each section and grade separated intersections at Jadibuti and Sallaghari intersection.

### II.3 FATALITY FROM ROAD TRAFFIC ACCIDENT IN GUINEA

Most of the deaths were among occupants, motorcyclists, pedestrians, and the productive workforce aged 25 - 49 years. It

was found that majority of the death happened in Upper Guinea followed by Forest Guinea. Improvement of roads design, strict enforcement of road safety laws and raising the awareness of general public about the causes and risks factors of road traffic accident through various channels are highly required which will promote economic growth in the local communities and then help people escape the poverty trap [10].

#### **II.4 INJURY PATTERN AMONG ROAD TRAFFIC ACCIDENTS' VICTIMS**

Young male drivers in Najran recorded the highest frequency of RTAs' victims with 58% of the RTAs happened in the evening. Amongst road traffic injuries (RTI), head injury represented 36% of cases, followed by lower limb and spinal injury (23% for each) with neurological deficits occurred in 8% of cases. Since RTI are a major health problem in Saudi Arabia which negatively impact national economy, studying pattern of road traffic injuries is a useful tool to focus on and identify the causes of RTAs. Although study did not focus on the causes of RTAs, it is important to minimize them by enhancing law enforcement of traffic policies. Regulations regarding driving license release as well as license renewal should be promoted with adoption of psychophysiological tests along with initiation of road safety education and expansion of Saher system (road camera surveillance) deployment [11].

#### **II.5 QUANTIFYING THE INFLUENCE OF ROAD GEOMETRIC PARAMETERS ON ROAD SAFETY**

The analysis showed that short and sharp (i.e.,  $R \leq 450$  m) horizontal curves were associated with higher crash frequencies. For wider curves (i.e.,  $R > 750$  m), the effect of horizontal curve elements on road safety is found to be not consistent and hence it may be highly affected by the availability of other risk indicating road parameters rather than horizontal curves elements. Generally, the frequencies of average accidents decreased as the radius of the curve, transition curve length and super-elevation of horizontal curves jointly and/or alone increased. The numbers of horizontal and vertical curves per 1.5 km road segments were positively correlated with the average accident frequencies. Furthermore, it was also found that the first horizontal curve after a long tangent was the most critical curve and the risk was 1.5 times greater than that of the tangent section. Grade of the road was positively correlated with average number of accidents per segments. Furthermore, an increase of around 69% and 11% in number of accidents identified when the road section transformed from flat to mild grade and from mild to steep grades respectively. Wider lane and/or shoulder width produces fewer numbers of average accidents. In average, 22% and 29% of accident frequencies have been reduced due to 0.15 and 0.2 m land and shoulder width improvement respectively. Finally, even though traffic police report underestimated the influence of road geometry on road safety in Ethiopia, substantial improvements of expected number of accidents have been quantified when the road section parameters improved [12].

#### **II.6 DETERMINING THE CRASH-REDUCTION**

The crashes on high-risk rural roads should be identified on improving roads' safety by providing more information and tools for the FHWA High-Risk Rural Road Program (HRRRP). Fatal and incapacitating-injury crashes on Kansas' rural major collectors, rural minor collectors, and rural local roads were

analyzed for five- year crash data, and the predominant crashes types that were identified were fixed-object crash, run-off-road crash, overturned crash, rear-end crash, and head-on crash. Various possible countermeasures and the CRFs for each predominant crash type were gathered from the literature, and the CRF values were validated for high-risk rural-road usage by conducting interviews with Kansas county engineers/officials [13].

#### **II.6.1 Road Safety Management Systems in the European Countries**

The analyses revealed that all the countries are different when the RSM systems are considered as a whole, making it impossible to identify typical RSM structures or a single best working model at a national level. However, it is possible to compare countries when the RSM areas are considered separately, where the clusters of countries recognized the patterns common for the European countries. A further indication of a correlation between a higher level of the RSM system and better safety performance of the country was also provided. Among the countries, a higher availability level was observed for the presence of a strong lead agency, a national medium-term road safety program, quantitative targets, NGOs or government agencies actively advocating for taking road safety action, "benchmarking" progress related to other countries, systematic data collection, using research results and a media coverage of the road safety issues. Clearly, these "good practice" features are common today for the RSM of the developed countries. On the other hand, low availability was found for most policy implementation and funding components, including a lack of dedicated budget, insufficiency of human resources, etc. The additional weak points of the RSM systems were: distribution and coordination of responsibilities between various management levels, and (un)availability of sustainable and results-focused structures which would enable effective implementation, funding, monitoring and evaluation of the road safety activities [14].

#### **II.6.2 Overloading a Vehicle and Road Safety**

Due to overloading the vehicle will be less stable, difficult to steer and take longer to stop. Overloaded vehicles can cause the tyres to overheat and wear rapidly which increases the chance of premature, dangerous and expensive failure or blow-outs. The driver's control and operating space in the overloaded vehicle are diminished, escalating the chances of an accident. Brakes have to work harder due to 'the riding of brakes' and because the vehicle is heavier due to overloading. Brakes overheat and lose their effectiveness to stop the vehicle [15]. Overloaded trucks pose serious threats to road transport operations, with increased risks for road users, deterioration of road safety, severe impacts on the durability of infrastructure (pavements and bridges), and unfair competition between transport modes and operators. A reduction in overloaded trucks is also conducive to a reduction in crashes [16].

#### **II.6.3 Accident Caused by Overloaded Trailers**

When a semi-truck is overloaded, or the load is improperly loaded, even the most experienced drivers can experience a dangerous accident. Overloaded trailers are difficult to safely transport and drivers may be unaware that they are carrying a dangerous trailer. When they take a turn on the highway, turn sharply to navigate city streets, or try and safely stop in traffic, the



unpredictable trailer load may turn over, cause the vehicle to jackknife, or prevent the driver from safely coming to a stop [17].

### II.6.4 Trucking-Accidents Due to Overloading

It is important to understand the various ways in which overloaded vehicles can be involved in accidents. There is never a reason for a driver or trucking company to overload a truck. There are several common causes of overload accidents, the breaking distance increases for overloaded vehicles. As a result, the ability to stop quickly decreases when a vehicle is overloaded, improperly secured cargo can shift position in a truck, leading to a rollover. Jackknifing can occur when vehicles are overloaded. When a vehicle jackknifes, other people in the immediate area are at risk of being seriously injured or killed, tires can be blown out because a vehicle is carrying too much weight, too much weight can put a tremendous strain on vehicle's mechanical systems, resulting in many different types of structural failures, Vehicles with too much weight can experience difficulty in maneuvering corners, which can easily result in rollovers [18].

## II.7 ROAD SAFETY STATUS IN SASEC COUNTRIES

SASEC is contributing in three sectors, with substantial progress as Transport, Trade Facilitation, and Energy. SASEC's achievements on the ground are shown in terms of the three priority land transport corridors, which are especially improving Bhutan's and Nepal's access to key markets and gateway ports and their prospects for participating in regional and global value chains. SASEC document concludes with a reminder that increased connectivity and mobility, with rising numbers of vehicles plying longer routes, bring with them a higher risk of road accidents, in the absence of adequate safety measures. Most of the SASEC sub-region has experienced a worsening accident trend since 2010, stressing the need for a more concerted action for safe mobility. Rising Risk of Accidents/Burden of Accidents is high for low- and middle-income countries. So, South Asia Need for Better Safety Record for its Roads.

### II.7.1 Road Safety Status in Bangladesh

Road safety is a challenging issue in Bangladesh. On average, 2410 lives claims death every year during last five years. Number of Road Traffic Accident (RTA) deaths is 6.93 per 10,000 motor vehicles and 16.32 per 100,000 populations in 2018. Number of Road Traffic Accident (RTA) deaths per 10,000 motor vehicles dropped from 10 in 2014 to around 7 in 2018. Vulnerable Road Users (VRUs) account for 80% of road traffic accidents fatalities. Government is concerned about the growing road safety problems to combat against such trauma. Some pragmatic programs have been taken to ensure safer transportation. Efforts are underway for integrating different public and private organizations civil societies, communities and individuals developing effective measures to address road safety problems [19].

#### Factors leading to the road accidents and resultant fatalities:

- Link to Driver: Unauthorized overtaking, over speeding, over loading, Lack of professional knowledge, Violation of traffic law, Using Mobile Phone while driving, driving without taking adequate rest, Having Drug and others.
- Linked to Vehicle Owners: Irregular Maintenance of vehicles, recruiting unlicensed, unqualified and unskilled drivers on day basis, inadequate number of drivers for the fleet.

- Linked to Pedestrians: Careless and inattentive movement/road crossing, using mobile phone while crossing road, Habit of not using the Pedestrian crossing/foot over bridge/ underpass.
- Linked to Infrastructure: Lack of Proper Maintenance with safety features like road marking & sign signal on roads, Encroachment, Unplanned intersections.
- Linked to Vehicle: Improvised and unfit Vehicles, Unauthorized changes in size & design, mixed traffic (motorized & non-motorized) Analysis of National Data (contd.).

#### Measures Taken to reduce road accidents:

Enactment of "Road Transport Act, 2018, Covers the common reasons of accidents with severe penalty and high punishment in National Road Safety Strategic Action Plan 2017-2020, Improve the quality of sign and marking on national and regional highways, Establish Axle Load Control station for controlling overloading, Remove unauthorized speed breakers, obstructions, encroachments on highways, Grade separation on Major-Major intersections, Railway overpass at level crossings, Safety issues addressed in all road designs, 473 kilometer road upgraded to 4-lane divided carriageway. 500kms road safety audit conducted, 394 kilometer SMVT lane being constructed, banning more than 20 years old vehicles on road, banning three Wheeler & NMT on National Highways, Strengthening Driver Training Programme, Rehabilitation, Operation & Maintenance, Steps have been taken to establish Motor Driving Testing and Training Centre in each division and greater district, Vehicle inspection manual prepared, District administration also conducting mobile courts in district level.

### II.7.2 Road Safety Status in Bhutan

In Bhutan road traffic fatality is in decreasing trend. The target was to reduce 13-15 deaths per 10,000 vehicles to less than 10 deaths per 10,000 vehicles by 2020 and in 2019 it was 8.85 death/10,000 vehicles. Annual road safety education & awareness programs conducted annually and implementation of strategies for use of road safety measuring devices with regular monitoring of drug/alcohol abuse by drivers and Monitoring of driving institutes for road safety standards [20].

#### Measures Taken to reduce road accidents:

Highway inspection, Vehicle road worthiness inspection, Inspection for use of alcohol and drugs, Passenger bus drivers and taxi drivers on periodic basis, Private vehicle drivers are inspected at random, Road Safety Audit, Fines & penalties for traffic violation. Policy framework for efficient road safety, Ban of import of used cars, adhoc drug/alcohol test, Enforcement of traffic law, right of way for pedestrians, 100% usage of no honking unless necessary, use of helmets (two-wheelers), Road Safety for students, Initiated data collection and analysis, Observation of Zero tolerance day, Introduction of green no. plate (EV), Introduction of green tax to counter environmental impact through emission (focus on eco-friendly EVs).

### II.7.3 Road Safety Status in India

India alone accounts for close to 11% of global road deaths with 0.151 million deaths in 2018 and number 1 leading cause of deaths for children & young adults aged between 5-29 years. NH and SH (5% of total road network) account for 55% of road



accidents and 63% of road accident deaths. Road Accident victims are large in age group of 18-45 year. Motorized two wheelers account for highest share of Road Fatalities and over speeding accounted for maximum number of deaths due to traffic rule violations. Objective on road safety is 25% reduction in fatalities by 2024 (in line with overall aim of 50% fatality reduction by 2030) [2].

#### **Some initiatives:**

Identification and rectification of accident black spots, Training and capacity building, Road Safety Audits, Installation of crash barriers, Reducing PCU for four Laning NH, Speed Control Standard, Vehicle Tracking System in Public Service Vehicles, Speed limit/ Speed Alert System, ABS system in M1, M2 categories and in Two wheelers, Automatic Head Light On, Air Bags, Weight losses in New Helmet Design, Bus Body code, Electric, Ethanol and Methanol Vehicles exempted from Permits, Truck Body code, Red Beacon Lights, Advisory on Linking of PUC data (emission related data) with the VAHAN database, Crash Tests, Promoting Intelligent Transport System (ITS), Enforcement of Road Safety Laws, Electronic Monitoring and Enforcement of Road Safety, Post-crash response and trauma care – NHARSS, Good Samaritan Guidelines, Incident Management System on NH, National Programme on Trauma Care, Emergency Medical Services for road Accidents, Inspection and Certification Centers, Mass action treatments on high risk crash corridors, Reduce Speed Limits in school zones, Point to Point and mobile speed cameras, Speed warning systems deployed on all vehicles, Mandating detachable seat belt and enforcing child restraint system usage, Standards for helmets & Enforcing use of safety devices, Constitution of Urban Road Design Unit (URD), Undertake traffic signaling studies cities >50K population, Interventions against driving under influence (DUI), Good Samaritan Guidelines, First Responder Trainings, Ambulances with GPS devices, Single emergency /accident reporting number, Penalty / bonus payments for golden hour treatment, Cashless insurance schemes, Optimizing Road Use, Monitoring & Evaluation, Road Safety Advocacy, Road Safety Management, Education and Awareness activities are conducted.

#### ***II.7.4 Road Safety Status in Maldives***

Road accident fatality in 2015 was 12 persons in 1845 accident cases and in 2018 it was 14 in 1887 accident cases. Road safety is maintained by the road users and road monitors but negligence on road safety is seen in Maldives that leads to traffic congestion and accidents. There are some challenges to change the road user's behavior and some steps are taken to minimize the road accident like improvement in road infrastructure, strengthening the Rules and Regulations and conducting the awareness programs. Major factors noticed are speeding, missing road signs, Overtaking, Distance between two vehicles, Parking techniques, Road Infrastructure, Pedestrians crossing blindly, Mobile phone usage [21].

#### **Some initiatives:**

Development of road infrastructure design guideline, driving behavior and Speed management, Speed Regulations have been amended, Traffic Police monitoring System, Compulsory awareness program for new drivers, Revised Regulations, introduce public transport system, introducing certificate of entitlement, Emphasis on environment friendly vehicles, Changing

License Number plates to steel plates, Camera readable plates, Upgrading software (vehicles information data base). Road rallies to promote and aware people on road safety, Accidents drama on the road, T-Shirts with messages, message boards and banners, conducting compulsory awareness program for new drivers, amending all related regulations, Awareness Programs like use of Helmet, Social Media Importance of maintaining speed limit, Intensify monitoring and enforcement.

#### ***II.7.5 Road Safety Status in Myanmar***

There were 16167 road accident cases with 5325 people's death in 2019. Majority of accidents seen in two wheelers with 41% vehicles involved, personal vehicles involvement 13% and truck 14%. Road Safety Action Plan (2021-2030) is being updated in the following 6 sectors: (a) Institutional management, implementation management and management for human resources and finance (b) Provision of traffic rules and regulations for road safety (c) Safer Vehicles (d) Safer Pedestrians (e) Post-crash Care and Emergency Services (f) Education and Enforcement for Road Safety and Data Collection of Road Accidents to research [22].

#### **Some initiatives:**

Injury Surveillance System in major hospitals, Trainings for Advocacy on leadership for road safety and strengthening capacity on post-crash response and Initial Emergency care, first aid trainings/Establish Emergency Care Units/Establish emergency call center/Set up hotline number (192) for road accidents and health Current RS Data Collection, collect road accidents data.

#### ***II.7.6 Road Safety Status in Sri Lanka***

Sri Lanka is a tropical island surrounded by the Indian Ocean and its history dates back to over 2500 years having current population of 21 million. Hilly terrain at center, hot plain beaches along the coast, ancient historic ruins and monuments and varying climate condition are attractive features of Sri Lanka. Rapid motorization from 3,125,794 in 2007 to 6,795,469 (2.17-time increase) in 2016. Increase in road accident fatalities with 2176 in 2008 to 2994 in 2018 (1.37 times increase) with 8-9 deaths per day due to road accidents. Road Development Authority total road network (2019) is about 116682 Km with 12438 km National Roads, 81321 km Local roads and 4000 km other roads [23].

#### **Some initiatives:**

Coordinating activities relating to road safety amongst governmental and nongovernmental organizations, paying compensation to persons injured in hit and run accidents, maintaining a database system, maintaining a library on road safety, maintaining relationships with like-minded international institutions and exchange of knowledge, Preparing and implementing projects on road safety, offering advice to the government on policies and projects connected with road safety.

#### ***II.7.7 Road Safety Status in Nepal***

Total Population of Nepal is about 29 million and Road Traffic Fatalities is 2789 in 2018/19 with approx. 7 people per day. Fatality in road accident is in increasing trend. Total Road Network of Nepal is about 92000 km with 77087 State/Local Roads and 14913 km National Highways. No. of registered vehicles 3.54 million (2018/19) about 72% two wheelers Annual loss due to Road crashes approx. US\$ 55 million. Road accident in urban area

is about 48%, in Highways 29% and in rural area is about 23%. Road safety action plan 2013-2020 is in implementation with no improvement in road crashes and is being updated [24].

**Factors leading to the road accidents and resultant fatalities:**

- Human factors: Driver behavior or fault, over speed, over Load, drunk driving, fatigue, violation of traffic rules, pedestrians (Reckless pedestrian crossing violating regulations, carelessness) etc.



Figure 2: Causes of accidents. Source: [24].

- Road condition: Poor visibility at blind corners, unsafe side-drains, very steep gradients at numerous sections, insufficient control system, slippery or skidding road surface, pot holes, narrow bridge approaches etc.



Figure 3: Causes of accidents. Source: [24].

Vehicle condition: engine, brake etc.

- Other causes: Advertisement boards, service stations, parking problems, no proper lighting system in street, less space for non-motorized transport, road encroachment, high beam headlight at night, unauthorized parking of vehicles, confusing traffic signs, back light not in condition, horn not used in curves, road

markings not maintained, weather conditions, careless cycling and walking on road.

**Some Initiatives:**

Formation of Road Safety Council 2017, Road Safety Audit in few new road constructions and upgrading projects, Revision in Nepal Road Standard, Comprehensive Driving License Test, Institutional establishment in concerned agencies, Road safety awareness among all stake holders, In-house trainings, Initiation of dedicated budget head for road safety. Road Safety Action Plan 2013-2020 is in implementation. Road Safety Audit Piloted in large projects funded by ADB/WB, Road Safety inspection done in strategic Roads, Speed limit law/Drink driving law/Helmet law/Seat belt law implementation, Time card system, Trauma center one in Kathmandu capital of country, Vehicle Fitness Testing Center One in Kathmandu.

**Guidelines and enforcement:**

- Infrastructure Related
  - Nepal Road Standard 2014
  - Road Maintenance Manual, DoR
  - Standard Specification for road and Bridges 2016
  - Design Manuals, DoR, Traffic Sign and Signals
- Road Safety related DoR Publications
  - Traffic Sign Manual Volume I & II
  - Road Safety notes
  - Road users Guide
- Technology based solution
  - RA-IMS Started from DoTM
  - CCTV Camera Installation Initiated
  - Planned: -Network Based Regulatory System (ITS)
  - Use of Radar Gun to check speed
  - Use of breathalyzer to control drinking drive
  - Weigh Bridges
  - Channelization

**Some effective practices in Nepal in Road safety:**

- Do not drink and drive program: (Enforcement + Education).
  - 35-50 thousand drivers are fine per year only in Kathmandu.
  - Enforcement: penalty + license punching (after 5 punching licenses cancel).
  - Education: need to take one-day class about traffic rules.

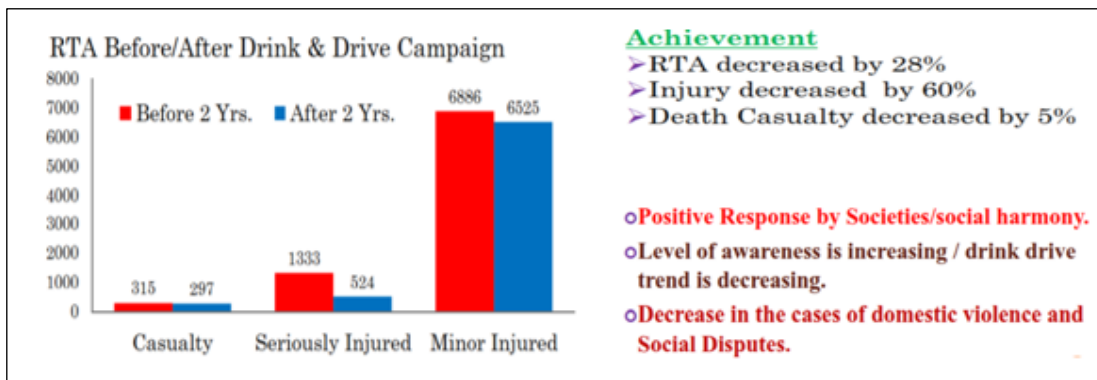

Figure 4: Comparison of two years' data on drink and drive campaign. Source: [24].

### **Time card system: For speed Control**

- Traffic Police launched this system and distributed the cards to drivers
- Drivers have to reach their destination within the time frame
- A separate time card has been allocated for heavy and small vehicles.

Major activities established within five pillars of Nepal Road Safety Action Plan 2013-2020 [25].

### **Pillar 1: Road Safety Management**

Revive the existing NRSC with necessary acts, higher authority and resume work, Develop the national road-safety action plan, Conduct training on road-safety & traffic rules, Develop and implement a pedestrian planning guideline and regulation, Review and update vehicle insurance policy, Identify amendments required in Existing Laws regarding RTS, Amend VTMR 1994 and LSGR 1999 to harmonize with UN/int'l conventions, Establish sound coordination mechanisms on managing road safety, Develop a national road-safety strategy and process for the government endorsement. Out of 19 actions targeted in road safety management 10 are yet to be implemented.

### **Pillar 2: Safer Roads and Mobility**

Pilot/Enforce and Implement RSA for all SRN and LRN, Introduce RS impact assessment, Black spot analysis and counter measures, introduce mandatory provisions for work-zone safety planning in the construction contracts, make road authorities legally responsible for reporting annually their progress, findings and remedial works performed for road-safety, Establish road-safety units in Municipalities. Out of 26 actions targeted in safer roads and mobility 15 are yet to be implemented.

### **Pillar 3: Safer Vehicles**

Develop and implement a safe-vehicle guideline, identify amendments required in VTMA 1993 and VTMR 1994 to incorporate the following, Review the route permit procedures, set up a central transport management committee, Upgrade DoTM institutional capacity, ensure all public vehicles are handicap accessible. Out of 22 actions targeted in safer vehicles 16 are yet to be implemented.

### **Pillar 4: Safer Road Users**

Develop a comprehensive code-of-conduct for all road-users (drivers, pedestrians, street-vendors), Conduct road-safety awareness campaigns, Update the existing textbooks on road-safety, publish and introduce in school curriculum, publicize road-safety through TV, radio and print media, introduce regular road-safety education programs for professional drivers, Improve driver license system, Institutional support for Traffic Police. Out of 16 actions targeted in safer road users 7 are yet to be implemented.

### **Pillar 5: Post-Crash Response**

Introduce a toll-free telephone number for medical emergencies, develop a national ambulance policy, provide trauma-care training to medical personnel at all levels (primary, secondary, tertiary), Investigate funding sources to assist rehabilitation of crash victims, conduct medical research on major injuries of crash victims, ensure people with disabilities are not deprived from employment opportunities. There are 6 Regional

Hospitals, 11 Zonal Hospitals, 5 Teaching Hospitals, 11 Central Hospitals, 56 District Hospitals, and 13 Small (15 bed) Hospitals under different levels of governments. In addition to plenty of privately owned hospitals. Although the 14th Periodic Plan had provisioned for trauma facilities in all hospitals near SRN roads, this has not been achieved. The 15th Plan has further planned to provide each municipality with a primary hospital equipped for primary trauma care service. Out of 11 actions targeted in post-crash response 6 are yet to be implemented.

The road safety strategy is Safe road-infrastructures and services backed with effective post-crash response and conducive environment resulting in little or no casualties from the RTAs. Horizontal coordination amongst the stakeholders to manage road-safety has been poor, ad-hoc, often hampered with duplication of activities from parallel committees set up under different agencies while interventions been arbitrarily implemented. A National Road Safety Council was set up in Nepal during the nineties but this body has been defunct and road-safety did not receive the due priority it demanded.

### **Some Activities of law Enforcement to Reduce Accidents by Traffic Police**

Traffic police of Nepal is responsible for regular operation of vehicles, traffic management on VVIP movement, traffic management during festivals, rallies and ceremonies, reduce accidents, vehicular traffic related public awareness programs and punishment/impose fines to those violating the traffic rules. Followings are some activities implemented by traffic police within capital city in 2019/20 to fulfill above responsibilities [26]:

- Three months' traffic awareness programs, pedestrian safety awareness/ law enforcement programs, public awareness program by musical programs, traffic police holding play cards about road safety on roads, one hr. awareness program conducted to drink and drive drivers, lane rule violators, road accident case drivers.
- Punishment to high sounded motorbike drivers, unauthorized parked vehicle drivers, door open vehicle drivers, looking glass related drivers, horn related cases, drink and drive cases.
- To minimize the congestion separation of flow of high speed and low speed vehicles on 4/6 lane roads, informative boards about traffic rules erected on roads, use of traffic cones to maintain lane discipline
- Implementation of long term and short-term traffic management action plan, use of volunteers to manage traffic during peak hours.
- Operation of traffic light installed/maintained by Department of Roads in the capital city for the management of vehicular traffic, use of surveillance vehicles, CCTV-Camera, Radar gun, breathalyzer to enforce the rules
- Use of road accident information management system (RAIMS) software developed and supported by Department of Transport Management
- Banning of heavy vehicles to enter in the capital city from 6:00am to 8:00pm., removal of hoot of the buses to reduce fatality during accidents.
- Coordination/Discussion with stakeholders to reduce accident rate and fatalities.



## Road Safety related documents in Nepal

**National Transport Policy 2058:** The construction, improvement and management of the means of transport shall be done in harmony with the traffic-safety and environment. The Constitution of Nepal guarantees under § 51 Policies of the State, it directs for a safe, systematic and disabled friendly transportation sector. The formation order for Road Safety Council is based on Good Governance Act 2064 and not on MVTMA. Hence the focus is rather on management than on prevention of road crashes as is seen in its objectives [5].

**Roads Board Act 2058:** Under § 25 use of Road Fund, RBN may finance road safety activities. But no mandatory provision.

**Local Government Operation Act, 2074:** As per § 11.Ta.4, the Rural Municipalities and Urban Municipalities are responsible for road safety management on the roads under their jurisdiction (i.e. non-strategic roads). However, the act does not elaborate further on goal and priority activities towards making the roads safer.

**Public Roads Act, 2031:** § 3Ka: to impose a 6m setback from road edge for permanent structure; This powerful authority to avoid possible vehicle-pedestrian conflicts has never been exercised.

**MVTMA 2049 and MVTMR 2054:** Only license bearers are allowed to drive; only license bearers are allowed to serve as conductor, commercial passenger vehicles to obtain route-permit, appointment and authority of Mobile Transport Inspectors; only road-worthy motor vehicles to ply, prohibition on using motor vehicles for non-registered purposes, safe and timely transport of passengers and goods, prohibition against overloading vehicles, rest for the bus driver and change of drivers, drivers are not to be disturbed, proper positioning of stopped vehicles, passengers to be seated, compulsory use of seatbelt by passengers on the front in a car and use of helmets by all riders of motorcycles, vehicles to stop at zebra crossings when being used, pedestrian not to walk on travel lanes, prohibition on straying of domestic animals, prohibition to drive under influence of alcohol or narcotics, crash victims to be helped, prohibition on reckless driving, speed control through traffic signs and standing orders, erection of traffic signs as per international conventions and their enforcement; providing bus laybys and parking yard, delineation of on-road work site, educating the general public.

- Guideline on workshops and repair centers
- Guidelines on bus route allocation
- Guidelines on loading control of goods vehicles
- Guidelines on operation of driver training centers
- Guidelines on vehicle fitness inspection and testing
- Guidelines on vehicular emission test
- Guidelines on bus body building
- Guidelines on school buses

**Labor Act 2049:** Vehicles on long routes shall have two drivers, Drivers could be fired if found to consume alcohol.

**Heavy Vehicle Management Policy 2005:** Heavy management Policy 2005 are relevant for road safety and are hardly referred by them in road design and construction. The policy focus is basically on effect of overloaded vehicles on pavement deterioration, nevertheless, it also discusses enhancing road capacity, enhancing road safety by adhering to vehicle manufacturers' specifications and road design standards.

**Road Safety Notes from 1996 to 1998:** Road safety notes includes following documents which are relevant for road safety and are hardly referred by them in road design and construction. Now these documents are compiled in one volume.

- Road Note 2: Design of Safe Side Drains
- Road Note 4: Road Safety Audit Manual
- Road Note 5: Delineation Measures

- Road Note 6: Safety Barrier
- Road Note 7: Safety at Bridges
- Road Note 8: Identifying and Treating Accident Sites
- Road Users' Guide
- Traffic Sign Manual

## Nepal's Commitments to the Global Community

**Busan Declaration:** Recognizing the urgency to address the issue, in 2007 in Busan, Declaration on Improving Road Safety in Asia and the Pacific, agreed to a goal of saving 600,000 lives and preventing a commensurate number of serious injuries on the roads of the region over 2007-2015, As no significant action followed the signing of the declaration, road fatalities in Nepal jumped from 785 in 2007 to 2004 in 2015. The SDGs, set in 2015 by the UN General Assembly and intended to be achieved by 2030. Target 3.6: By 2020, halve the number of global deaths and injuries from road traffic accidents. Target 11.2: By 2030, provide access to safe, affordable, accessible and sustainable transport systems for all, improving road safety, notably by expanding public transport, with special attention to the needs of those in vulnerable situations, women, children, persons with disabilities and older persons, Nepal has set a sub-target of 50% for proportion of population that has convenient access to public transport, and 80% for access to paved road within 30 minutes of walking

**1958 Agreement on Vehicle Regulations:** defines the minimum requirements that automobiles must satisfy in order to be approved for sale or use in a particular country or region, stop import of substandard accessories such as helmets, brake, tire, and seat-belt, rather than accession of the agreement itself, national standard for the accessories in conformity with the 1958 Agreement need to be developed

**1968 Convention on Road Traffic:** The Convention on Road Traffic is designed to facilitate international road traffic and to increase road safety by establishing standard traffic rules for motor vehicles and trailers in international traffic. Nepal requires to ratify this treaty, incorporate the provisions fully in MVTMA and MVTMR to make the roads safer. Nepal also needs to update and widely disseminate the Highway Code: including to the international traffic entering the country.

**1968 Convention on Road Signs and Signals:** The Convention is designed to increase road safety and aid international road traffic by standardizing the signing system for road traffic (road signs, traffic lights and road markings) in use internationally. Nepal should consider to apply for Accession of the treaty.

**1975 Agreement on Minimum Requirements for Driving Permits:** The 1975 Agreement on minimum requirements for the issue and validity of driving permits elaborate the 1968 Convention on Road Traffic. Nepal requires to ratify this treaty, incorporate the provisions fully in MVTMA and MVTMR to produce qualified drivers for the local traffic as well as to issue International Driving Permits.

**1997 Convention on Technical Inspection of Vehicles:** Adoption of Uniform Conditions for Periodical Technical Inspections of Wheeled Vehicles and the Reciprocal Recognition of such Inspections. Nepal needs to establish a network of VFTC throughout the country in adequate numbers and use the test parameters including those specified in the treaty.

**1998 Convention on Global Vehicle Regulations:** As Nepal is neither a vehicle producing nor exporting country, the existing provision in MVTMR banning to change the properties of purchased motor vehicles suffice.



**2018 WHO Voluntary Targets for Road Safety:** Setting indicators for voluntary global performance targets relating to road safety risk factors and service delivery mechanisms can assist national and global road safety policy efforts. not ratified by the UN General Assembly.

**2.14 Star Rating of Highways**

The Australian Government and State and Territory governments have agreed on a National Road Safety Strategy 2011-2020 (NRSS) with the goal of reducing the number of deaths and serious injuries from road crashes by at least 30 per cent by 2020. Recent progress has been insufficient and are in danger of not meeting the national road safety targets. Cost effective countermeasures to improve safety have the potential to prevent deaths and injuries for decades after they are implemented. We should strive to create a genuinely safe road system in which improving the safety of drivers, vehicles and roads is of mutual importance. A road system in which we have 5-star drivers in 5-star cars on 5-star roads should involve no deaths. The AusRAP Star Rating process identifies the national highways which lack adequate safety-enhancing design elements. The Star Rating also serves as an information source for motorists wishing to determine the level of safety of roads. The Star Ratings and SRIPs, which are the focus of this report, measure the inherent safety of a road’s infrastructure – that is, the degree to which built-in safety features prevent crashes from occurring and reduce the severity of those crashes which do occur. Some Safety Countermeasures adopted are: Roadside barriers, Central median barrier (no duplication), Shoulder rumble strips, Skid resistance (paved road), Protected turned lanes, Additional lane etc. [27]. For the first time the United Nations has included road safety as a Sustainable Development Goal (3.6). The UN Global Road Safety Performance targets are now providing a common standard to benchmark the safety of the world’s roads. 3-star or better roads for all road users is a key target for all of our partners to embrace as we work together to create a world free of high-risk roads. Ensuring more than 75% of travel is on 3-star or better roads for all road users by 2030 will save lives on a scale that matters [28].

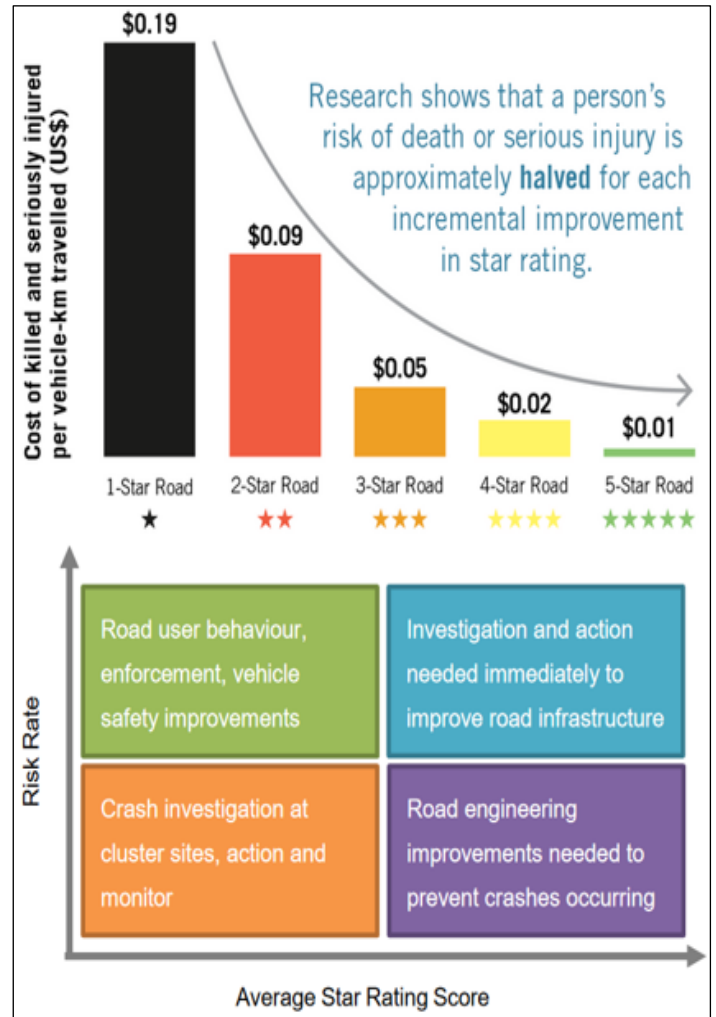

Figure 5: Prioritizing routes using risk rates and Star Rating Scores.

Source: [29].

Table 1: Criteria for Star Rating.

Star Rating	Pedestrian	Bicycle	Motorbike	Cars
★	No side walk, No safe crossing, 60km/hr traffic	No cycle path, No safe crossings, poor road surface, 70km/hr traffic	No motorcycle lane, undivided road, trees close to road, winding alignment, 90km/hr traffic	Undivided road with narrow centerline, trees close to road, winding alignment, 100km/hr traffic
★★★	Side walk present, pedestrian refuge, street lighting, 50km/hr traffic	On-road cycle lane, good road surface, street lighting, 60km/hr traffic	On-road motorcycle lane, undivided road, good road surface, >5m to any roadside hazards, 90km/hr traffic	Wide centerline separating oncoming vehicles >5m to any roadside hazards, 100km/hr traffic
★★★★★	Sidewalk present, signalized crossing with refuge, street lighting, 40km/hr traffic	Of-road dedicated cycle facility, raised platform crossing of major roads, street lighting	Dedicated separated motorcycle lane, central hatching, no roadside hazards, straight alignment, 80km/hr traffic	Safety barrier separating oncoming vehicles and protecting roadside hazards, straight alignment, 100km/hr traffic

Source: [1].

**II.7.8 IRAP Star Rating**

iRAP star rating is a tool that assesses the safety standard of a road against safe system principles. The star ratings are based on road inspection data and provide a simple and objective measure of the level of safety which is ‘built-in’ to the road. The higher the star rating, the safer the road. The star rating of a road depends on a variety of factors relating to the nature of the road. As a result, motorways, with fewer merging junctions and more roadside barrier, normally

have higher star ratings than non-motorways. Similarly, dual carriageways, with opposing flows of traffic being physically separated, tend to have higher star ratings than single carriageways. iRAP believes that improving the world’s roads to a 3-star or better standard is a key way to achieve the SDG target of halving road deaths and injuries by 2020. 3-Star or better roads for all road users presents a realistic target for national and regional governments and road authorities to adopt [30].

III. MATERIAL AND METHODS

III.1 DATA ON ROAD SAFETY – BANGLADESH [19]

Table 2: Time series data on road accidents and fatalities.

Year	Accidents	Death	Injury	Vehicle Registered	Percentage of accident
2014	2027	2067	1535	2,142,083	
2015	2394	2376	1958	2,463,298	
2016	2566	2463	2134	2,879,708	
2017	2562	2513	1898	3,300,106	
2018	2609	2635	1920	3,797,480	
2019				4,301,610	

Source: Authors, (2020).

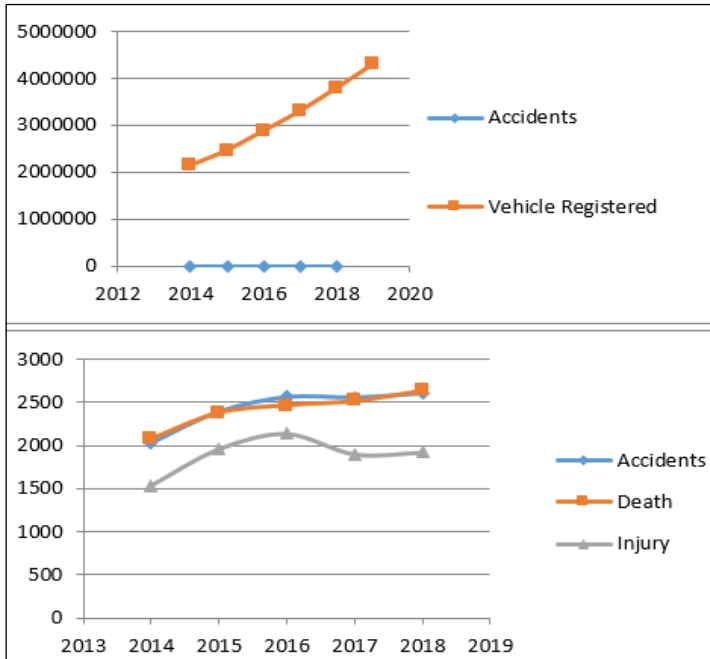

Figure 6: Vehicle, accident and fatality relationship.  
Source: Authors, (2020).

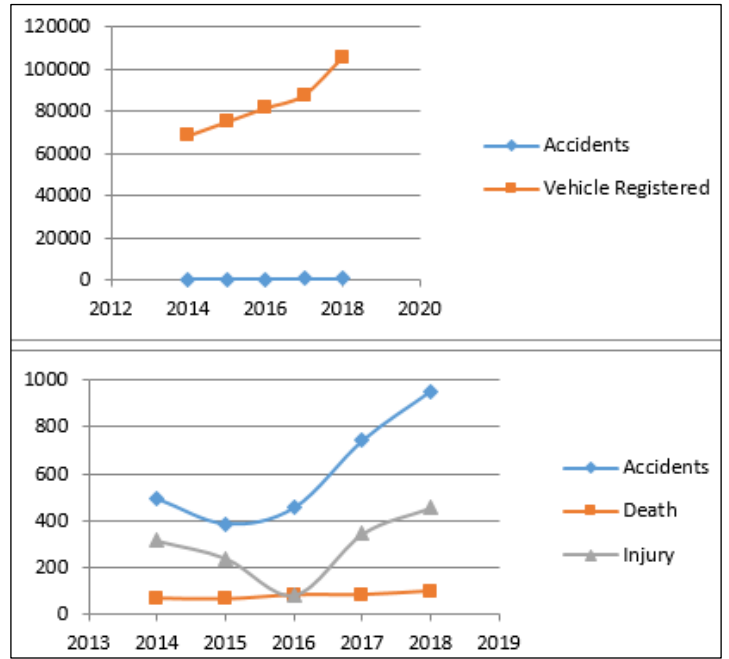

Figure 7: Vehicle, accident and fatality relationship  
Source: [19].

Table 3: Vehicle registration is increasing in linear trend but accident trend remains somehow stable in last three years  
Accidents by Vehicle Category.

Bus	Bikes/Auto	Truck	Car/Microbus	Nosimon
27.40%	34.83%	16.40%	7.82%	3.55%

Source: Authors, (2020).

Vehicle registration is approximately increasing in linear trend but accident trend is initially in decreasing trend and from 2016 in increasing trend.

Table 4: Vehicle types involved in accident.

EME	MB	Taxi	HV	MV	TW	LV
2.6%	1.6%	9%	13.9%	3%	1.6%	68.3%

Source: Authors, (2020).

III.2 DATA ON ROAD SAFETY – BHUTAN [20]

Table 3: Vehicle Population (Approx.) and road crash data by year.

Year	Accidents	Death	Injury	Vehicle Registered
2014	493	70	315	68500 (from Graph)
2015	387	67	240	75000 (from Graph)
2016	456	84	84	81500 (from Graph)
2017	741	85	346	87500 (from Graph)
2018	950	100	457	105000 (from Graph)
2019				

Source: Authors, (2020).

Table 5: Distribution of accident by gender.

Male	Female	Unknown
83%	5.4%	11.6%

Source: Authors, (2020).

Table 6: Gender and age group involved in accidents.

Age Group	25 Yrs	26 Yrs	27 Yrs	28 Yrs	29 Yrs	30 Yrs	31 Yrs	32 Yrs
Male	99	119	108	115	145	110	109	109
Female	13	2	3	0	7	17	11	8

Source: Authors, (2020).

Table 7: Distribution of Accident by Causes with Death and Injuries.

Death / Injuries	Human Factor	Environmental factors	Vehicle factors	Road factors	Unknown
Death	145	39	24	21	39
Injuries	705	94	75	21	87
Total accidents	1304	81	117	78	81

Source: Authors, (2020).

### III.3 DATA ON ROAD SAFETY – INDIA [2]

Table 8: Road safety scenario.

Year	Accidents	Death	Injury	Vehicle Registered [31]
2014	489400	139671		190386054
2015	501423	146133		209689528
2016	480652	150785		229650234
2017	464910	147913		253000000
2018	467044	151417		

Source: Authors, (2020).

Table 9: Road death based on Gender and Age in 2018.

Gender/Age	Less than 18	18-25	25-35	35-45	45-60	60 above
Female	2160	3942	5017	4462	3455	1732
Male	7817	28835	34943	28210	19343	7343

Source: Authors, (2020).

Table 10: Road death based on type of vehicle.

Year	Bus	Auto	2 wheelers	Car	Truck
2017	10651	6762	44092	31183	23483
2018	10507	6624	47560	30811	23868

Source: Authors, (2020).

Table 11: Road accident deaths based on traffic rule violation.

Year/Causes	Driving on wrong side	Use of Mobile Phone	Jumping red Light	Drunken Driving	Over-speeding
2017	9527	3172	1826	4776	98613
2018	8764	3707	1545	4188	97588

Source: Authors, (2020).

Table 12: Road Accident based on License Type and Non Use of Safety Devices.

Year	Without License	Learner’s License	Valid License	Without Helmet	Without seat Belt
2017	48503			35975	26896
2018	37585	23593	345799	43614	24435

Source: Authors, (2020).

Table 13: Road accident deaths based on type of collision.

Year	Fixed object	Vehicle overturn	Hit from side	Pedestrian	Hit from back	Hit and run	Head on collision	Others
2017	4283	9413	12071	18886	22446	25866	24170	21910
2018	4623	9548	15477	22656	25801	28619	29646	38975

Source: Authors, (2020).

### III.4 DATA ON ROAD SAFETY – MALDIVES

Table 14: Data on Accidents and Road Fatalities.

Year	Accidents	Death	Injury	Vehicle Registered
2014	1836			68208
2015	1845	12		
2016	2073	04		71796
2017	1954	12		
2018	1887	14		
2019		09		

Source: [21] and [32].

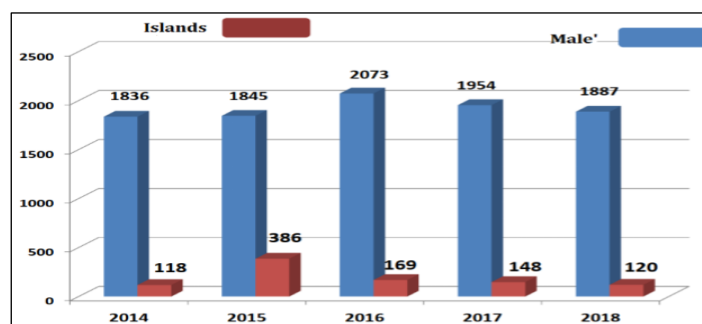

Figure 8: Road Accidents-5 years' data (2014-2018).

Source: Authors, (2020).

### III.5 DATA ON ROAD SAFETY – MYANMAR

Table 15: Trend of Road Accidents Data (2010~11/2019).

Year	Accidents	Death	Injury	Vehicle Registered
2010	7985	2264	14130	2300696
2011	8568	2495	15316	2356286
2012	9339	2653	15720	3616268

Source: [33].

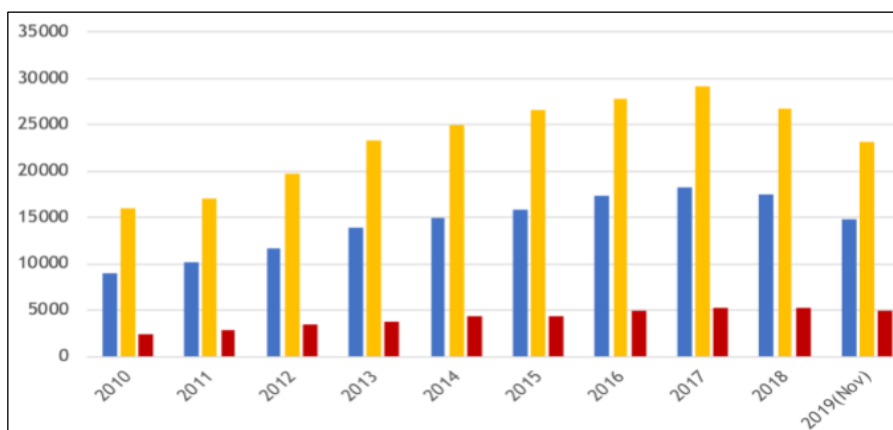

Figure 9: Trend of accident data 2010-11/2019.

Source: [33].

Table 16: Cases with respect to Impacting vehicles by Types (1/2019~6/2019).

Type of vehicle	Personal Vehicle	Truck	Bus	SPV	Two wheelers	Three Wheelers	Farm Truck	Machinery	Other
Percentage	13	14	9	9	41	2	4	1	7

Source: Authors, (2020).

Table 17: Cases with respect to Causes of Road Accidents (1/2019~6/2019).

Causes	Driver's error	Pedestrian's error	Vehicle's error	Road's error	Weather	Total
Nos. of cases	8208	309	203	5	3	8728

Source: Authors, (2020).

Table 18: Accidents by Types of Driving License, Age and Gender (1/2019~6/2019).

Types of License	Under 16 yrs		16 to 20 yrs		20 to 30 yrs		30 to 40		Over 40 yrs		Total	
	M	F	M	F	M	F	M	F	M	F	M	F
A-1	1	-	48	1	81	7	74	3	67	3	271	14
A	-	-	351	13	606	46	402	40	439	30	1798	129
B	-	-	121	1	495	9	417	13	349	11	1392	34
C	-	-	1	-	49	1	68	1	59	-	177	2
D	-	-	-	-	87	-	133	6	107	10	327	16
E	-	-	-	-	140	2	414	3	308	2	862	7
F	-	-	3	-	23	-	25	-	17	-	68	-
G	-	-	9	-	19	-	21	-	13	-	62	-
T	-	-	111	-	24	-	9	-	1	-	145	-

Source: Authors, (2020).

### III.6 DATA ON ROAD SAFETY - SRI LANKA [22]

Table 19: Time series data on road accidents.

Year	Accidents	Death	Injury	Vehicle Registered
2014		2439		3125794 in 2007
2015		2816		
2016		3017		6795469 in 2016
2017		3147		
2018		2994		
2019				

Source: Authors, (2020).

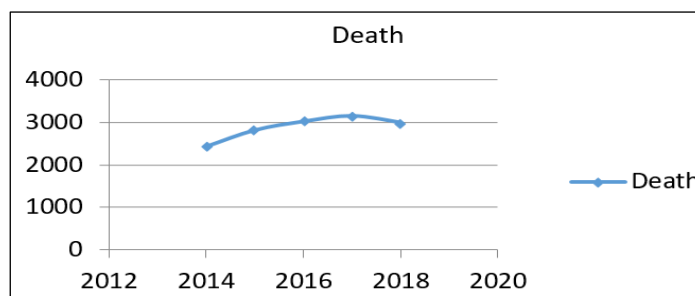

Figure 10: Road fatality over last 5 years Year.

Source: Authors, (2020).



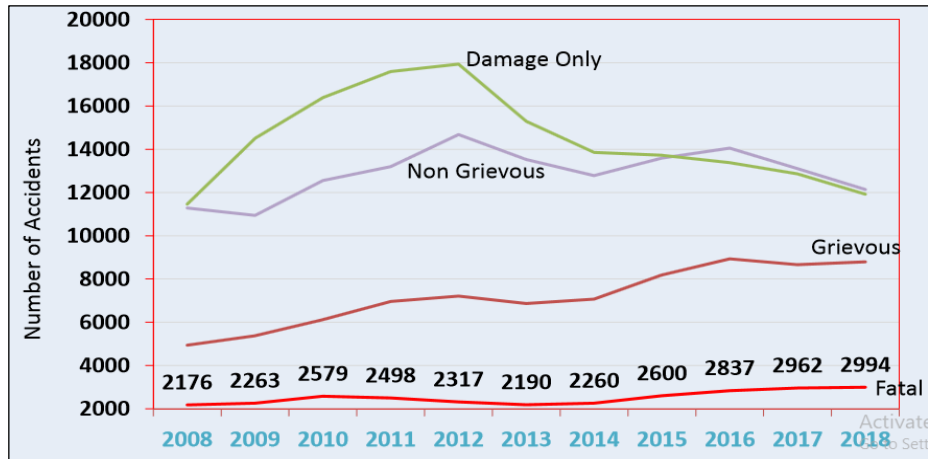

Figure 11: Variation of accidents over the last ten years.  
Source: Authors, (2020).

Table 20: Percentage of deaths by road user category.

User/Year	2014	2015	2016	2017	2018
Passenger	23	25	22	20	
Pedestrian	29	29	30	30	
Others	47	46	49	49	

Source: Authors, (2020).

Table 21: Road accident deaths based on type of collision.

Head on collision	Rear end	Crash with pedestrian	Others
19%	20%	17%	44%

Source: Authors, (2020).

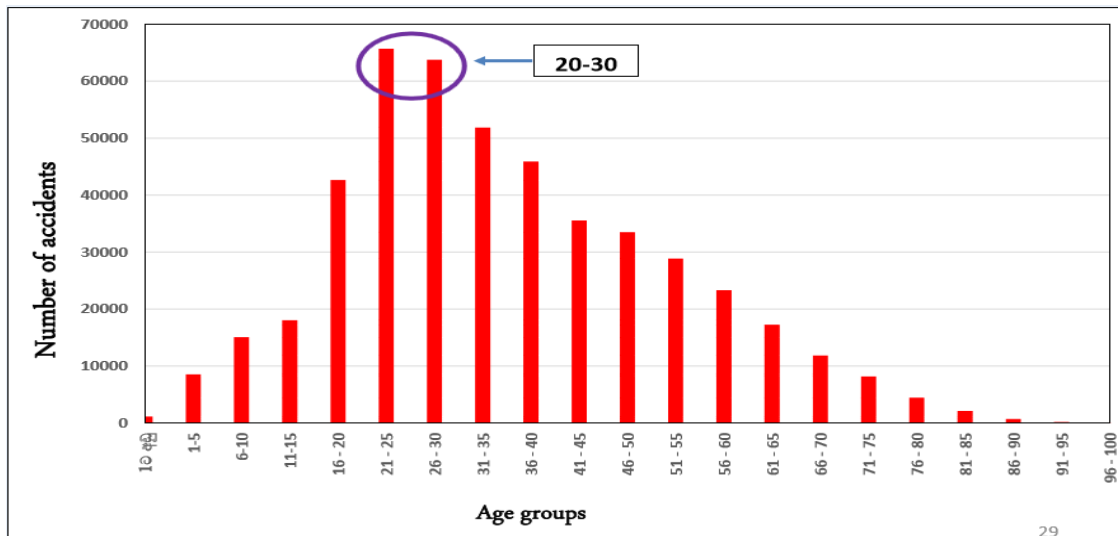

Figure. 12: Variation of number of accidents by age of victim.  
Source: Authors, (2020).

### III.7 DATA ON ROAD SAFETY - NEPAL [24]

Table 22: Road Crashes and Injuries data.

Year	No. of Accidents	Death			Severe Injury			Normal Injury		
		Male	Female	Total	Male	Female	Total	Male	Female	Total
2015/16	10013	1603	403	2006	3161	1021	4182	6025	2188	8213
2016/17	10178	1914	470	2384	3275	975	4250	5978	2312	8290
2017/18	10965	2044	497	2541	3183	961	4144	6033	2214	8247
2018/19	13366	2218	571	2789	3343	1033	4376	7352	3008	10360
2019/20*	15554	1827	428	2255	3674	951	4617	7982	3243	11225

\* Data affected due to Covid-19 Lockdown for 3.5 months of Fiscal year 2019/2020.

Source: Authors, (2020).

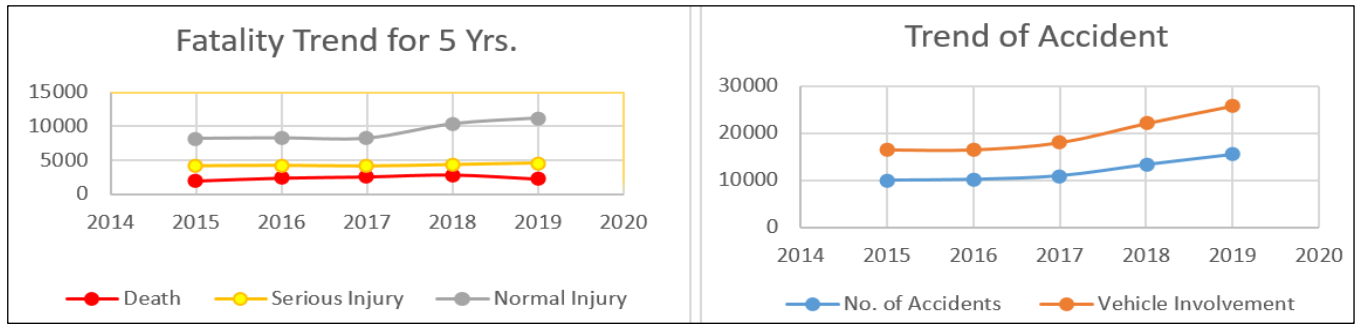

Figure 13: Accident, Vehicle Involvement and road fatality relationship. Source: Authors, (2020).

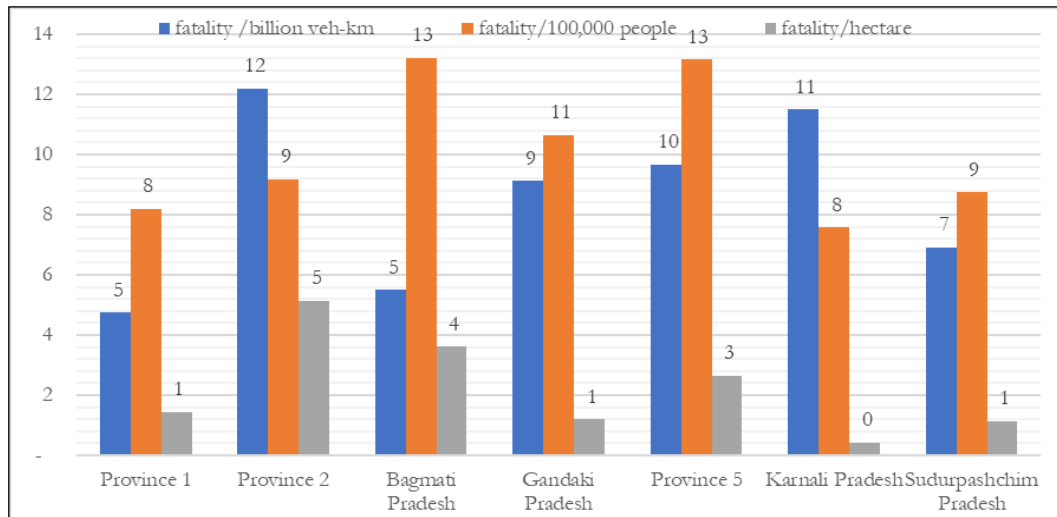

Figure 14: Exposure of risk against road fatality. Source: [5].

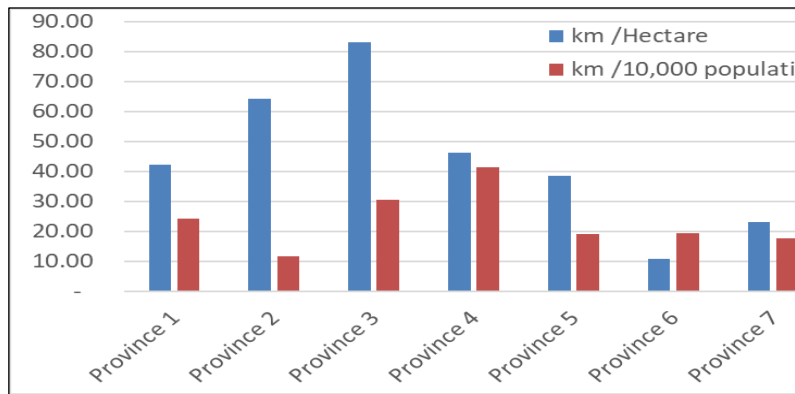

Figure 15: Road densities. Source: [5].

Table 23: National accident data by road category.

Urban (valley)	Highways	Rural
48%	29%	23%

Source: Authors, (2020).

Table 24: Involvement of vehicle in accident.

Year	Heavy	Bus	Car, Jeep	Tractor	Tampoo	Motorcycle	Sha.sa	Other	Total
2015/16	1921	1970	4528	690	200	6365	757	71	16502
2016/17	2230	2043	4608	645	220	6152	510	107	16515
2017/18	2430	2005	5212	602	237	6874	563	111	18034
2018/19	2685	3224	6079	628	338	8553	465	115	22087
2019/20	2679	2936	7563	606	405	10869	604	127	25789
<b>Average%</b>	<b>12.07</b>	<b>12.31</b>	<b>28.29</b>	<b>3.21</b>	<b>1.42</b>	<b>39.23</b>	<b>2.93</b>	<b>0.54</b>	<b>100.00</b>

Source: Authors, (2020).

Table 25: Accidents with respect to time.

Year	06:00-12:00	12:00-18:00	18:00-24:00	0:00-06:00
2017/18	3179	4450	2812	524
2018/19	3699	5372	3645	670
Dec, 2019- half year	2626	3623	2509	484

Source: Authors, (2020).

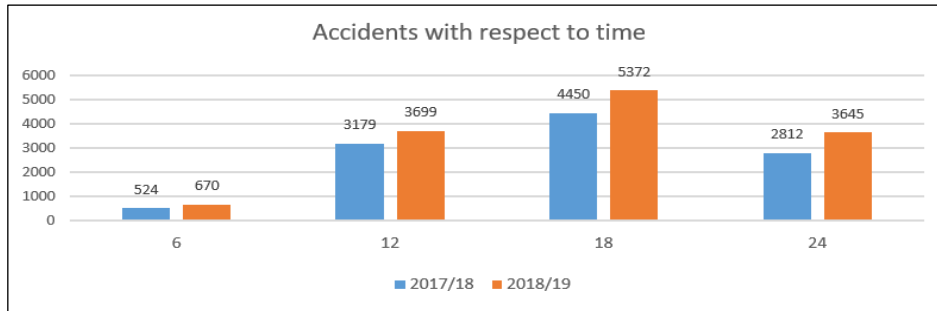

Figure 16: Accidents with respect to time.

Source: [5].

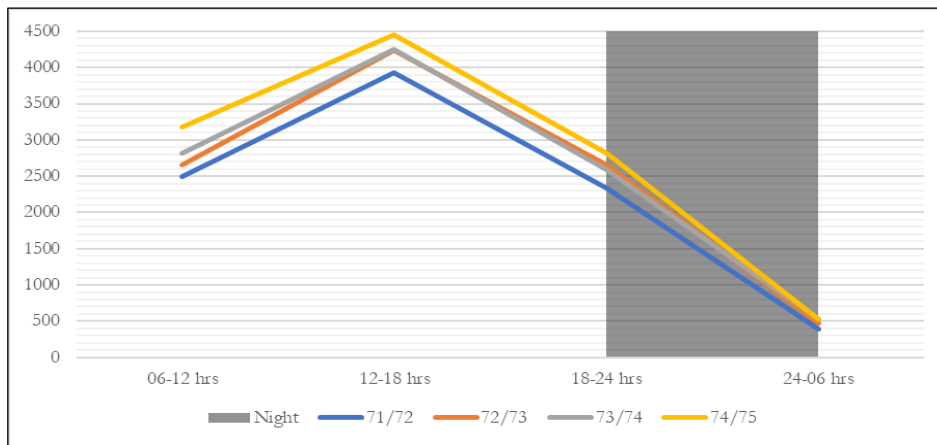

Figure 17: Accidents with respect to time.

Source: [5].

Table 26: Accidents with respect to cause of accident.

Year	Driver's negligence	Passenger	Over take	High Speed	Drink Drive	Vehicle condition	Over load	Anim als	Road condition	Weat her	Total
2017/18	8461	272	136	1395	311	204	39	15	117	15	10965
2018/19	9136	198	263	2171	416	206	27	8	114	27	13366
2019/20 Half year	6899	92	140	1455	384	141	20	27	83	18	9244

Source: Authors, (2020).

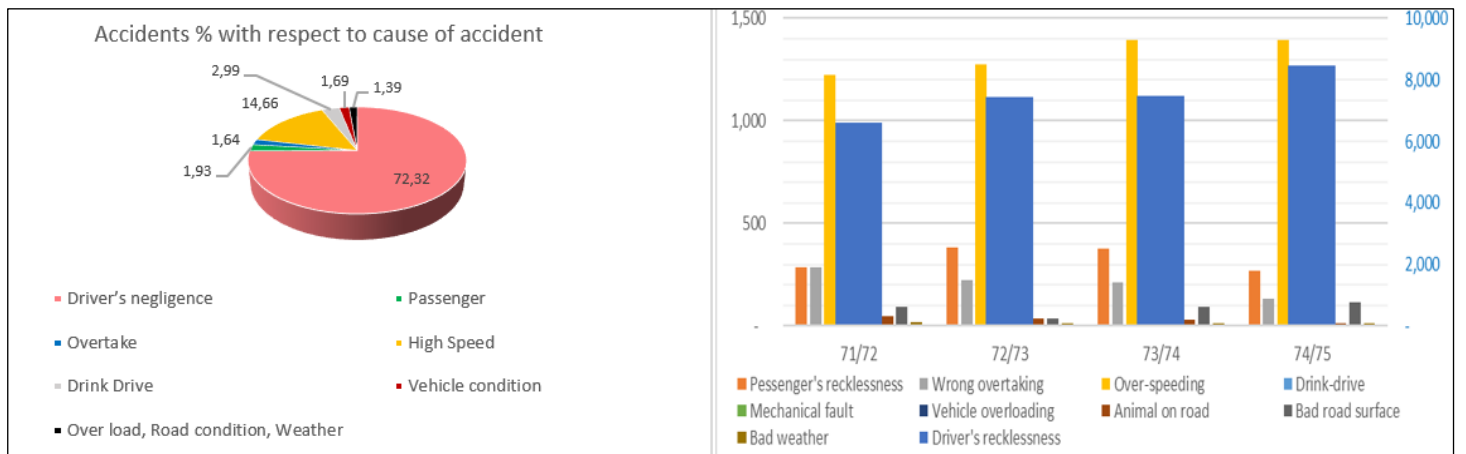

Figure18: Causes and Accident (Thickness of bar considered) from FY (2014/15).

Source: [5].

Table 27: Analysis of national data by age of victim, 2019.

Below 6 yrs				6-16 Yrs				16-25 Yrs				>25 Yrs			
Male		Female		Male		Female		Male		Female		Male		Female	
Deat h	Injure d	Deat h	Injure d	Deat h	Injure d	Deat h	Injure d	Deat h	Injure d	Deat h	Injure d	Deat h	Injure d	Deat h	Injure d
54	256	48	172	91	585	46	382	647	4575	92	1401	1210	4172	344	1693

Source: Authors, (2020).

Table 28: Death rate in road accident estimated per 10000 motorized vehicles (excluding 2 and 3 wheelers), 2019.

Age group of Population	Percentage of Casualties	Death rate per 10000 motorized vehicles
Children under 5 Yrs.	9%	4.45
Children from 5-15 Yrs.	21%	10.38
Young people 15-40 Yrs.	44%	21.74
Elder people 40- 55 Yrs.	12%	5.59
Elder people 55 Yrs.	14%	6.92
<b>Total</b>	<b>100%</b>	<b>49.42</b>

Source: Authors, (2020).

Table 29: Vehicle Composition: Registration Data.

Year	Bus	Mini bus	Heavy	Car	Pickup	Micro	Tempoo	Motorbike	Tractor	Others	Total
Up to 2013	30560	12968	43023	132154	16852	1383	4742	1121625	83406	309108	1755821
2014/15	3737	2270	4236	13560	6957	932	1541	196383	10524	343	239240
2015/16	4353	4625	8328	28361	5060	1137	2613	267439	9786	12063	331702
2016/17	5342	2008	12712	21292	10675	841	17782	354071	17085	2451	441808
2017/18	2972	1973	12154	24338	10342	1934	16209	341623	13396	12673	424941
2018/19	2354	1751	9958	17953	6987	1431	9785	249581	9765	8912	309565
Total	49318	25595	90411	237658	55973	7658	52672	2530722	143962	345550	3503077
Percentage	1.41	0.73	2.58	6.78	1.6	0.22	1.5	72.24	4.11	9.86	100.00

Source: [4].

### III.8 AWARENESS/LAW ENFORCEMENT/FINE/PENALTY DATA WITHIN KATHMANDU VALLEY IN 2019/20 [26]

Table 30: Data of law enforcement by traffic police.

SN	Activities/Enforcement	Number	Remarks
1	Lane Discipline awareness program	1,34,043	Total vehicle running in Kathmandu valley is 15,08,537 In FY 2019/20 and violation of rules recorded 4,11,512 vehicles with total fine/revenue of NPR 26,21,72,000 was collected.
2	Haphazard crossing pedestrian's awareness	19,998	
3	Traffic police Musical team mobilized awareness	7,700	
4	Penalty to drink drive	24,350	
5	Lane rule violators	28,449	
6	Road accident involved drivers	289	
7	Number plate rule violators	1,542	
8	High sound motorbike riders and wrong driving	197	
9	Unauthorized parked vehicles	40,637	
10	Vehicle operation with door opening	21,412	
11	Looking glass not in condition	15,191	
12	No horn rule violators	14,327	

From above data percentage of road traffic rule violators is 27.28 i.e. about one third drivers did not obey the traffic rules in the valley.

Source: Authors, (2020).

Table 31: Analysis of fatality with respect to Vehicle and population.

Year	Total Death	Total Vehicle	Vehicle in 10000	Death per 10000 vehicles	Death Per day (average)	Population in 100000 [34]	Death Per 100000 Population
2015/16	2006	2326763	232.68	8.62	5.50	27.26	7.36
2016/17	2384	2768571	276.86	8.61	6.53	27.63	8.63
2017/18	2541	3193512	319.35	7.96	6.96	28.09	9.05
2018/19	2789	3503077	350.31	7.96	7.64	28.34	9.84
2019/20	2255*	3713262 <sup>1</sup>	371.33	6.07	6.18	28.60	7.88

\*Data affected due to Covid-19 Lockdown for 3.5 months of Fiscal year 2019/2020.

Source: Authors, (2020).



<sup>1</sup>Data not available and calculated considering 6% growth rate

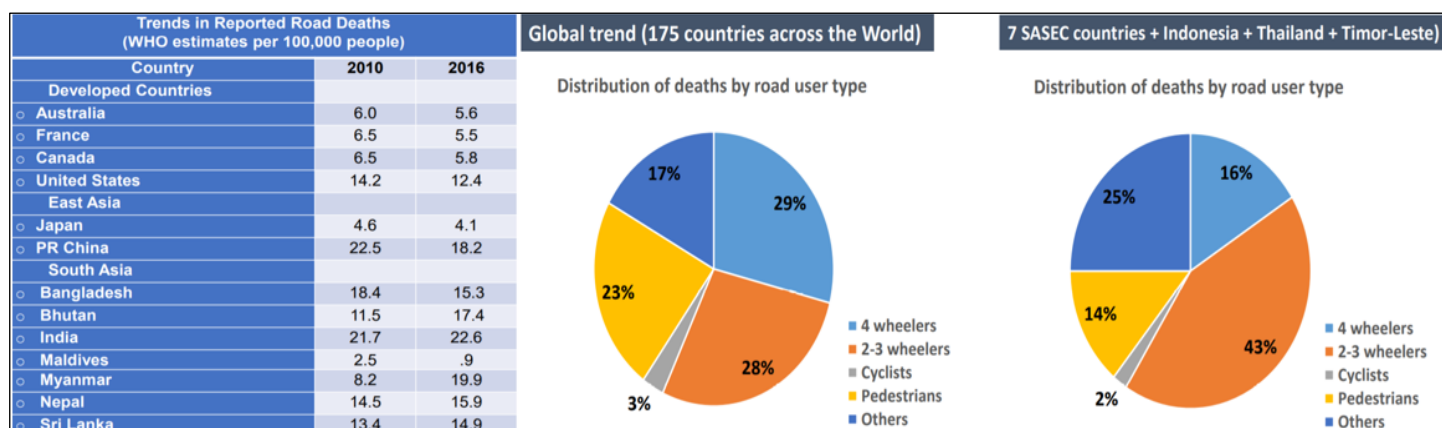

Figure 18: WHO 2018 Global Status Report on Road Safety.

Source: [1].

### III.9 GAP IDENTIFICATION BETWEEN TARGETED AND ACTUAL FATALITY DATA

The number of road deaths should come down to 810 in 2020 if Nepal would have responsibly followed the SDG Goals, or to 810 by 2030 if the grace period provided by the Stockholm Conference 2020 is considered. However, it is likely to hit 3,000 in 2020 and 5,000 in 2030 if the effort to lower the road deaths remain at the present level.

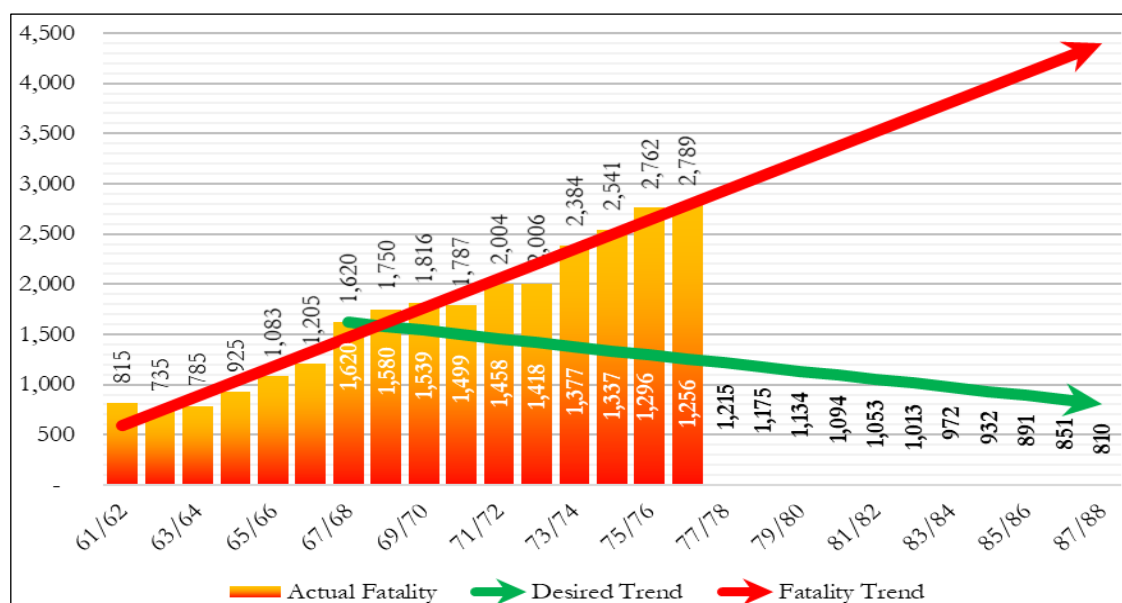

Figure 19: Gap Identification on targeted and actual fatality (BS 61/62 is equivalent to 2004/05 AD and BS 87/88 equivalent to 2030/31AD).

Source: [5].

### III.10 GAP IDENTIFICATION BETWEEN TARGETED AND ACTUAL FATALITY DATA

Table 32: Comparison of Road Safety Status.

Country	Total Death	Vehicle in 10000	Death in 10000 Vehicle	Death Rate per 100000 Population
Nepal	2789	319.35	7.96	9.05, Population = 28.09 million
India	151417	25300.00	13.00	11.67, Population = 1.353 billion
Bhutan	100	10.50	9.52	13.20, Population = 754,394 Nos.
Bangladesh	2635	379.75	6.93	16.32, Population = 16.14 million [35]
Maldives	14	8.80	1.59	2.71, Population = 515,696 Nos.
Myanmar	5325			
Sri Lanka	2994	679.55	4.40	13.90, Population = 21,413,249 Nos.

Source: Authors, (2020).

From the table India bears the highest death rate per 10000 motor vehicles and Bangladesh bears the highest death rate per 100000 populations in 2018. Death rate due to road crashes in Nepal seen to be 7.96 per 10000 motor vehicle and 9.05 per 100000 populations. Death rate in Maldives seems to be as low as 1.59 per 10000 motor vehicles and 2.71 per 100000 populations. Some of the above data are calculated from unofficial data sources like presentations or websites. So, may not represent the real figure because WHO presented the different figures on the same matter.

#### IV. RESULTS AND DISCUSSION

- Road Safety is a critical theme globally with about 1.35 million deaths annually.
- Road accident became the 8<sup>th</sup> leading cause of death globally and 3 times higher deaths rate in low income than in high income countries.
- Considering the registered vehicles in SASEC countries, India bears the highest death rate due to road traffic accident (13 per 10000 vehicle) in 2018.
- Considering the population in SASEC countries, Bangladesh bears the highest death rate of 16.32 persons per 100000 populations in 2018.
- Road traffic fatalities in Nepal is 7.96 persons per 10000 vehicles and 9.05 persons per 100000 populations in 2018/19 and is in increasing trend i.e. no improvement in road traffic safety.
- In Nepal, major portion of vehicle composition is of two wheelers (72.24%) and involvement of two wheelers in accident is the highest 39.23% on average, heavy vehicles (Trucks and Buses) about 12/12% and that of car is 28.29% on average with highest rate in an urban area.
- Peak traffic hours in Nepal is from 9:00AM to 7:00PM and accident rate at that time is also high. Also, driver's negligence is the major cause (72.32%) of accident followed by over speed (14.66%).
- Road Traffic Accident (RTA) related fatalities and injuries continue to be an important morbidity and mortality problem, as well as a health finance problem.
- Road traffic crash data are useful tools to support highway safety programs.
- Accidents that occurred closest to an intersection would be more likely to end in injury or fatality.
- There will be increase in accident immediately after completion of the widening of road and decrease in the successive years if safety measures are not installed as per set guidelines.
- Age is another major cause of accidents; 15 - 45 years' age group is found to be the vulnerable group and most of the deaths were among occupants, motorcyclists, pedestrians, and the productive workforce.
- Young male drivers recorded the highest frequency of RTAs' victims happened in the evening.
- The analysis showed that short and sharp horizontal curves were associated with higher crash frequencies and the crashes on high-risk rural roads should be identified on improving roads.
- Due to overloading the vehicle will be less stable, difficult to steer and take longer distance to stop. Overloaded trucks pose serious threats to road transport operations, with increased risks for road users, deterioration of road safety, severe impacts. When a semi-truck is overloaded,

or the load is improperly loaded, even the most experienced drivers can experience a severe accident.

- 5 of 7 SASEC countries reported higher death rates between 2010 and 2016 so there is need for SASEC countries to better deal with safety record.
- Improving the world's roads to a 3-star or better standard is a key way to achieve the SDG target of halving road deaths and injuries.
- From law enforcement data of Kathmandu valley percentage of road traffic rule violators is 27.28 i.e. about one third drivers did not obey the traffic rules in the valley.

#### V. CONCLUSION AND RECOMMENDATIONS

Education, Engineering and Enforcement are the major sectors to reduce the rate of accident. With due priority we should focus on them and for this several activities may be implemented by allocating sufficient dedicated budget on road safety. Some recommendations can be listed as:

- Update the Nepal Road Safety Action Plan 2013-2020 to be realistic, implementable from all concerned agencies by harmonizing the vehicle management acts/regulation/guidelines/policies with the UN conventions, international agreements on road-safety and strict implementation of them.
- Establish realistic and long-term national targets for improving road-safety. Develop the network-based accident data recording/ dissemination system and conduct researches on road safety countermeasures on all roads and implement the suggestions.
- Install coordinated self-actuated traffic control system (Intelligent Traffic Signal System) with sufficient bus bays to stop the local public transport in major cities, remote monitoring of speed and traffic volume and remote controlling of traffic flow, SMS/email delivery of traffic violation tickets, and so on.
- Ensure the road safety measures during design of roads by introducing mandatory provision of safety audit and implementation of the recommendations. Introduce road-safety impact assessment and controls in all land developments projects.
- Explore for mass passenger transportation system. Provide access control in high speed highways through grade separated crossings, prohibit right turn where possible and barriers with proper and timely maintenance of the roads confirming to the standards. Introduce mandatory provisions for work zone safety planning in the construction contracts.
- Conduct Skill Development Training in safe-roads and awareness programs regularly and adopt Scientific licensing and route permits techniques. Include road safety in the next revision of formal and informal education curricula, teachers' guide and standard reference material.
- Adopt the policy of importing safer vehicles. Strictly enforce restrictions on vehicle modifications and introduce modern, scientific vehicle testing with strict enforcements by establishing sufficient responsible vehicle fitness centers (Testing information linking to centralized database system and proof in bluebook).
- Set up a network of ambulance services along the major highways, urban and rural roads providing trauma-care training to medical personnel at all levels with expertise

on treatment of road accident victims. Develop and maintain a comprehensive injury surveillance system in hospitals and health centers. Introduce a nationwide toll-free number and an empowered dispatch center at each district/local level hospital to call ambulance.

- Adopt mandatory provision of minimum parking area requirement in all residential/public/commercial buildings, control door/shutter opening for commercial propose to the roadside and control street vendors.
- Include road safety and a safe system approach as an integral element of land use planning, road design, transport system planning, education and governance and develop methodology to prioritize investment in road safety projects considering technical, economic and social issues as parameters.
- Establish sustainable source of funding for managing road. Tie requirement for RSA at Feasibility, DPR, Pre-Opening and Operation stage for both the SRN and CRN roads with budget allocation for subsequent phase.

Control overloading of freight trucks through installation of weighing stations at border crossing points and along major trade corridors with network based overloading detection and information system.

## VI. ABBREVIATION

ADB/WB	: Asian Development Bank/World Bank
BRT	: Bus Rapid Transit
DOR	: Department of Roads
DPR	: Detail Project Report
GDP	: Gross Development Product
GPS	: Global Positioning System
ITS	: Intelligent Transportation System
LRN	: Local Road Network
LSGR	: Local Self Governance Regulation
MVTMA	: Motor Vehicle Transport Management Act
MVTMR	: Motor Vehicle Transport Management Regulation
NH	: National Highway
NMT	: Non-Motorized Transport
NRSC	: Nepal Road Safety Council
PCU	: Passenger Car Unit
RS	: Road Safety
RSA	: Road Safety Audit
RSM	: Road Safety Management
RTS	: Road Traffic Safety
SASEC	: South Asia Sub-Regional Economic Cooperation
SDG	: Sustainable Development Goal
SH	: State Highway
SRN	: Strategic Road Network
UN	: United Nations
UNRSC	: United Nations Road Safety Council
VFTC	: Vehicle Fitness Testing Center
WHO	: World Health Organization

## VII. AUTHOR'S CONTRIBUTION

**Conceptualization:** Krishna Nath Ojha.

**Methodology:** Krishna Nath Ojha.

**Investigation:** Krishna Nath Ojha.

**Discussion of results:** Krishna Nath Ojha.

**Writing – Original Draft:** Krishna Nath Ojha.

**Writing – Review and Editing:** Krishna Nath Ojha.

**Resources:** Krishna Nath Ojha.

**Supervision:** Krishna Nath Ojha.

**Approval of the final text:** Krishna Nath Ojha.

## VIII. REFERENCES

- [1] WHO The Global status report on road safety, 2018.
- [2] Country paper presentation by India in the Conference on Safe Mobility and Regional Connectivity 20-22 January 2020, New Delhi, India.
- [3] Nepal police, Road accident data 2019.
- [4] <https://www.dotm.gov.np>.
- [5] MoPIT, Nepal, Draft final report on Review of Nepal Road Safety Action Plan, 2021-2030, 2020.
- [6] Albert Coleman, Road Traffic Accidents in Ghana: A Public Health Concern, and a Call for Action in Ghana, (and the Sub-Region), 4 November 2014.
- [7] Azad Abdulhafedh, University of Missouri-Columbia, MO, USA, Road Traffic Crash Data: An Overview on Sources, Problems, and Collection Methods, 2017.
- [8] Giovanni Bryden, Eric Catig, Wen Cheng Department of Civil Engineering, California State Polytechnic University, Pomona, USA, Causal Exploration of Bike Accidents in the Bay Area: June 18, 2012.
- [9] Guru Prasad Adhikari, Road Traffic Accidents (RTAs) Trends on Kathmandu-Bhaktapur Road after Addition of Lanes - 1 June 2016.
- [10] Keita Mamady, Bin Zou, Sylla Mafoule, Jiabi Qin, Keita Hawa, Keita Fodé Lamine, Guoqing Hu, Fatality from Road Traffic Accident in Guinea: A Retrospective Descriptive Analysis, 1 November 2014.
- [11] Mahdi Yahya Al-Zamanan, Abdullah Saleh Al-Yami, Ali Abdullah Al-Najrani, Mansour Yousef Al-Asmari, Abdulrahman Alamri Manaa, Awad Mohammed Al-Qahtani, Mohammed Helmy Faris Shalayel, Abdulhadi Mohamed Elbashir, Saeed Ali Alsareii, Injury Pattern among Road Traffic Accidents' Victims in Najran City, Saudi Arabia, April 27, 2018.
- [12] Mandefro Terefe Abebe, Quantifying the Influence of Road Geometric Parameters on Road Safety (Case Study: Hawassa-Shashemene-Bulbula Rural Two-Lane Highway, Ethiopia), Jul. 23, 2019.
- [13] Ranjit Prasad Godavarthy<sup>1</sup>, Eugene R. Russell<sup>2</sup>, High-Risk Rural Road Safety Study and Determining the Crash-Reduction Factors for High-Risk Rural-Road Usage 6 January 2016.
- [14] Patterns and Particularities Victoria Gitelman, Etti Doveh, Investigating Road Safety Management Systems in the European Countries: September 30, 2016.
- [15] The Department of Transport, South Africa, <https://www.arrivealive.mobi/overloading-and-road-safety>.
- [16] Véronique Feypell-de La Beaumelle, Improving truck safety: Potential of weigh-in-motion technology, July 2010.
- [17] <https://www.gilmanbedigian.com/accidents-caused-by-overloaded-trailers-in-dc>.
- [18] <https://ferralarawfirm.com/trucking-accidents-due-overloading/>.
- [19] Country paper presentation by Bangladesh in the Conference on Safe Mobility and Regional Connectivity 20-22 January 2020, New Delhi, India.
- [20] Country paper presentation by Bhutan in the Conference on Safe Mobility and Regional Connectivity 20-22 January 2020, New Delhi, India.
- [21] Country paper presentation by Maldives in the Conference on Safe Mobility and Regional Connectivity 20-22 January 2020, New Delhi, India.
- [22] Country paper presentation by Myanmar in the Conference on Safe Mobility and Regional Connectivity 20-22 January 2020, New Delhi, India.
- [23] Country paper presentation by Sri Lanka in the Conference on Safe Mobility and Regional Connectivity 20-22 January 2020, New Delhi, India.

- [24] Country paper presentation by Nepal in the Conference on Safe Mobility and Regional Connectivity 20-22 January 2020, New Delhi, India.
- [25] Nepal Road Safety Action Plan 2013-2020.
- [26] Bhim Prasad Dhakal, Presentation on Traffic police progress report by traffic police chief 2019/20.
- [27] Australian Automobile Association ABN 25008 526 36.
- [28] <https://www.irap.org/3-star-or-better/>.
- [29] [iRAP Star Rating and Investment Plan Implementation Support Guide March 2017](#).
- [30] Highway England, the strategic road network star rating report June 2019.
- [31] <http://mospi.nic.in/statistical-year-book-india/2018/189>.
- [32] <http://statisticsmaldives.gov.mv/nbs/wp-content/uploads/2015/10/Statistical-Pocketbook-of-Maldives2015.pdf>.
- [33] <https://www.ceicdata.com/en/myanmar/motor-vehicle-statistics>.
- [34] <https://tradingeconomics.com/nepal/population - date Aug 15, 2020>.
- [35] <https://www.google.com/search?population+of+bangladesh+in+2018>.





ISSN ONLINE: 2447-0228

## ITEGAM-JETIA

Manaus, v.7 n.27, p. 41-48. Jan/Feb, 2021  
DOI: <https://doi.org/10.5935/jetia.v7i27.731>



RESEARCH ARTICLE

OPEN ACCESS

## MOVING VEHICLE DETECTION FROM VIDEO SEQUENCES FOR TRAFFIC SURVEILLANCE SYSTEM

Jency Rubia J\*<sup>1</sup>, Babitha Lincy R<sup>2</sup> and Ahmed Thair Al-Heety<sup>3</sup>

<sup>1</sup> Assistant Professor, M.A.M. College of Engineering and Technology, Tiruchirappalli, India.

<sup>2</sup> Department of Electronics and Communication Engineering, Sri Venkateshwara College of Engineering, Bengaluru, India.

<sup>3</sup> Department of Electrical, Electronic and Systems Engineering, Universiti Kebangsaan Malaysia, Bangi, Selangor, Malaysia.

<sup>1</sup> <http://orcid.org/0000-0002-0088-3611> , <sup>2</sup> <http://orcid.org/0000-0003-2520-2410> , <sup>3</sup> <http://orcid.org/0000-0002-1863-9318> 

Email: \*jencyrubia@gmail.com, rblincy@gmail.com, ahmedth162@gmail.com

### ARTICLE INFO

#### Article History

Received: December 14<sup>th</sup>, 2020

Accepted: February 04<sup>th</sup>, 2021

Published: February 15<sup>th</sup>, 2021

#### Keywords:

Intelligent Transportation Systems, Automatic Moving Vehicle Detection, Traffic Surveillance System, Vehicle Counting, Vehicle Tracking.

### ABSTRACT

In the current scenario, Intelligent Transportation Systems play a significant role in smart city platform. Automatic moving vehicle detection from video sequences is the core component of the automated traffic management system. Humans can easily detect and recognize objects from complex scenes in a flash. Translating that thought process to a machine, however, requires us to learn the art of object detection using computer vision algorithms. This paper solves the traffic issues of the urban areas with an intelligent automatic transportation system. This paper includes automatic vehicle counting with the help of blob analysis, background subtraction with the use of a dynamic autoregressive moving average model, identify the moving objects with the help of a Boundary block detection algorithm, and tracking the vehicle. This paper analyses the procedure of a video-based traffic congestion system and divides it into greying, binarisation, de-noising, and moving target detection. The investigational results show that the planned system can provide useful information for traffic surveillance.



Copyright ©2016 by authors and Galileo Institute of Technology and Education of the Amazon (ITEGAM). This work is licensed under the Creative Commons Attribution International License (CC BY 4.0).

### I. INTRODUCTION

Computer vision is a widely exploiting research area in the applications like automation system, robotics, Optical Character Recognition, human-machine interface, Natural Language Processing, and video analysis [1]. Moving item tracking is an important research area in the computer vision applications. The finding and tracking of the moving target is essential in several applications, particularly in video surveillance system. This research has made an experiment on tracking and finding moving vehicles at the video surveillance scenario. The video surveillance system usually contains both static and moving objects. The main task is to identify the physical movement of a moving object in a particular area. The objects that are present in the video system can be determined by moving object techniques. This design supports the automatic finding and tracking of the moving vehicles from the video. The automatic finding of the moving vehicles is used to found a connection between targets or object parts in following frames and to extract temporal details about the

target like trajectory, speed direction, and posture [2]. Tracking of the moving vehicles is used to detect the objects frame by frame in video. It can be used in numerous regions such as video investigation, traffic monitoring and people tracking.

In the fast developing cities, Traffic organisation is becoming one of the most important concerns. May be a huge amount of man-hours get wasted due to bad traffic organization [3]. Growing traffic jams on public road and difficulties related with current detectors has created an attention in vehicle recognition equipment such as video image processing. Computerized motion detection and tracking is an interesting task in traffic surveillance. Data science based algorithms are the top most trending research topic. The humans has the ability to easily identify and recognize the moving targets from complex scenes in a flash. Transforming this knowledge to a machine requires data science based object detection algorithm with computer vision techniques [4]. One more thing, the human can't track the vehicles manually in heavy traffic areas. But the automatic computer vision based traffic surveillance system could easily

track a number of useful things simultaneously like number of vehicles presented in particular day, traffic time, types of vehicles crossing the road, and so on [5]. Video based traffic congestion observing systems are most puzzling problem. The urbanization drives the growing of traffic flow. Usually, traffic control is a complex issue, it requires monitoring. But the monitoring system are tedious. Recently, with the development of computer, network, image processing, transmission technology, and hardware, video monitoring systems are widely used in different domains and areas. But most of them rely on high Performance of hardware, limiting effectiveness and efficiency, especially in accuracy and response. Hence we will focus on optimization of the video input based traffic congestion observing system, mainly in image processing and moving object finding.

In this research, an arrangement is designed to collect beneficial statistics from stationary cameras for sensing moving items in digital videos. The moving detection and tracking system is created based on optical flow estimation composed with application and mixture of various relevant computer vision and image processing techniques to improve the progression [6]. Median filter is utilized to remove noise and the undesirable items are detached by applying thresholding algorithms with morphological operations. The tracking tool initially read out the video in frame format and then translates them into grey scale images. Also the object type restrictions are set using the blob analysis. The outcomes display that the proposed system productively detects and tracks moving vehicles in urban videos.

## II. MATERIALS AND METHODS

The huge rise of the vehicles is creating the roads full results in lot of traffic jam and it becoming more serious issue day by day. So, the finding to vehicles is of great importance [7]. Video tracking system is the most standard way of finding due to its vast advantage. Generally, the traffic management system uses the immovable and static camera for nonstop observation. It investigates the selected sequential images from the video and frame, in order to detect and track the moving item. Automated visual surveillance is currently a hot topic in computer vision research [8]. The proposed research can implement great useful high-value application such as surveillance, fighting crime, traffic management, etc. using object detection systems. The idea behind the detecting and tracking the moving target in videos is computer vision algorithm, since the object tracing is an attractive research in computer vision applications [9]. Most importantly the entire research is going to deal with video data. Usually the moving target detection problem follows multiple ways of techniques to resolve the issues. In that one of the main techniques is training the model with deep learning models or pre-trained model based training. These both methods are supervised learning methods and they have need of labelled files to train the object detection system. So the proposed work concentrates on the unsupervised way of object detection in videos, that means object detection without using any labelled data [10].

The objective of this project is to identify and track moving vehicles within a video sequence. The detection of the moving vehicle is depends on the optical flows between the two continuous video frames, which is opposite to the process of image background-based detection [11]. Moving target detection includes the following techniques Frame differencing, background subtracting, image thresholding finding contours, and morphological operation. Frame differencing is one of the main technique in moving object detection from video files. A video is

a combination of frames [12]. When tracking the moving vehicle in a video, that vehicle is at a different position at every frame. Other than these moving objects, other things will be stable in position. So in the process of frame differencing, noticing the pixel difference of the first frame from the following frame will highpoint the pixels of the moving object. The next process is image thresholding, in that step the pixels are assigned in two values based on threshold value. If the pixel value is less than threshold, then the pixel is represented as black and white colour; greater than threshold value pixel is represented by opposite value of previous representation. By using this image threshold, the unwanted part of the image will remove. The next steps are detecting the contours and image dilation [13]. The frame differencing is given in the equation form at Equation 1. Where 'Th' is threshold value.

$$|\text{Frame } i - \text{frames } i-1| > \text{Th} \quad (1)$$

The background subtraction techniques are the main process to diagnose the moving target from the sequence of video frames that varies considerably from a background [14]. Generally, the background image will demonstrate about the parts without moving target. So there are many practical challenges in choosing the best background subtraction technique. Mostly the researchers consider the frame differences to analysis the moving object and find object boundary, which may be pretty time consuming [15]. Since the video can be defined as sequence of frames which consist of images, where each sequence of image is displayed with high speed, so that normal human eye cannot visual the time gap among the frames. Mostly computer system uses a fixed still camera and it is used in object detection process much more feasible. Usually, a frame taken from a video sequence is split into two distinct set of pixels, where the next one is complementary to the first one. The first set belongs to the foreground object while the other one belongs to the background objects. The definition of foreground and background objects very much depends on the application being used [16]. Normally, the objects like people, vehicles, and animals etc. are considered as a foreground objects and rest of the things are considered as background. The background subtraction is displayed in Figure 1.

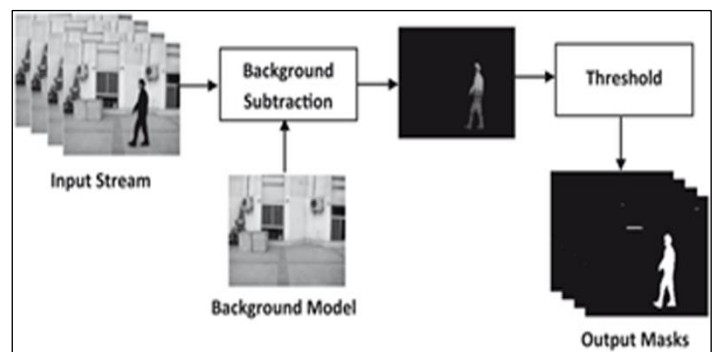

Figure 1: Back ground subtraction.  
Source: Authors, (2020).

Tracking moving vehicle from a video has different kinds of challenges like shadows, illumination issues, and quality of video in closed location [17]. When compare with close location, the open scenario based moving vehicle detection is more challenging due to moving shadows, and occlusion issues. So this section explains the challenges in moving vehicle tracking from a video. Illumination is the one of the main challenge. Illumination means false positive value, which is occurs due to variation in

lighting. In closed scenario light on-off changes is the main reason for illumination. At the same time, in closed location sun light, rainy clouds and reflection from other objects affects the tracking [18]. If the back ground colour is similar with moving vehicle colour also one of the reason for illumination problem. Complex background also affects the result of tracking moving vehicle from the input video.

### III. ARCHITECTURE OF MOVING VEHICLE TRACKING SYSTEM

As a core component of intelligent transportation, the real-time and effective vehicle counting method is of great significance for the expressway management department to implement traffic management and control violations. Since expressway has the characteristics of large traffic flow and high speed, once traffic jam and parking events occur, it is easily to cause traffic accidents, which is extremely harmful to traffic safety. Over the previous numerous years, video surveillance tools was connected in entirely key segments of the expressways, however the moving vehicle counting is still depends on sensors or simply out-dated image processing approaches, which consequences in serious road damage, costly information structure, and less moving vehicle counting accuracy. As a result, it is of best theoretical manner and practical manner significance to create full use of existing monitoring resources and apply the methods of modern algorithms and computer vision to study the video-based vehicle counting method for traffic violation handling, traffic guidance, and traffic safety.

The widely applied methods of vehicle counting mainly include vehicle detection and vehicle tracking. The initial stage vehicle recognition technique was to extract the moving goals from the input image frame from video sequence and recognize the extracted goals. The vehicle detection method during this era mostly encompassed background subtraction method, frame difference method, and optical flow method. On the other hand, the background subtraction technique considers the weighted average process for background update, and the consequence of background update will upset the integrity of the moving vehicle extraction and the precision of vehicle fining. Moreover, the frame difference technique is greatly affected by the vehicle speed and the time intermission of continuous frames. Additionally, the optical flow technique is pixel-level density estimation, which is not appropriate for instantaneous presentations due to its big calculation.

A tracking moving vehicle system from the video input for traffic management system is developed. The architecture design is exposed in Figure 2. The architecture of a tracking moving vehicle system contains the following steps such as frame converting, frame differencing, image thresholding, image binarisation, morphological operation, object location finding through foreground and back ground subtraction, vehicle detection and counting. Initially the input video is converted into separate frames [19]. Because, the video is made up of with sequence of frames. Next the frames are compared and find out the frame differencing output. Next the frames are involved into image thresholding, image binarisation, image dilation and morphological operation [20]. Background and foreground detection is the significant section of moving vehicle tracking systems that are very beneficial in traffic surveillance systems. Extracting the background and foreground from the input frames is known as background and foreground modelling. From the difference between the background and foreground modelling,

can be able to detect the moving vehicle from video sequence [21].

The proposed procedure is explained in this section. Initially, the input is selected as a scene, which should be taken from a static camera. This research work is concentrated on traffic surveillance. So the input test videos are carefully chosen from city surveillance videotapes [22]. First the videos are properly converted to proper and useful format. So certain pre-processing procedures have to be finished for creating the scene prepared to process. Due to the camera's auto white balance and the effect of sudden environment intensity changes, the mean of every frame is calculated on grayscale format [23]. The optical flow estimation is the essential part of the algorithm which is executed next. Filtering speckle, impulse and general external noises induced due to weather conditions is one of the supreme essential sections of the procedure. Median filter is used in our framework [24]. During filtering operation, some holes are created in the frames. To fill these holes and prevent detection mistakes morphological closing is implemented.

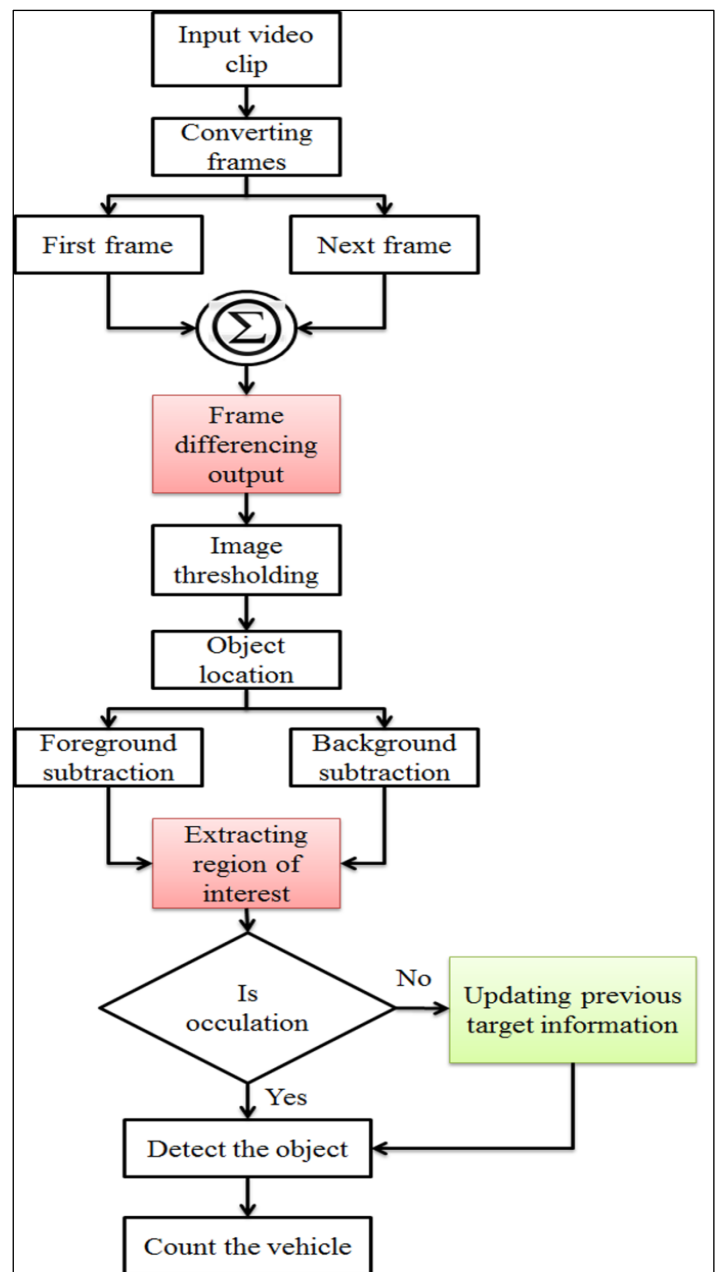

Figure 2: Architecture of moving vehicle tracking system. Source: Authors, (2020).



### III.1 IMAGE SEGMENTATION

Thresholding is the modest technique of image segmentation approach. From a grayscale input image, thresholding algorithms can be utilized to generate binary images. Thresholding function is considered to transfigure the grey level image to binary level image, so the objects of interest can be underlined by setting a threshold boundary. In the thresholding practise, if the pixel range is higher than selected threshold range, at that time those pixel values are noticeable as object; if the pixel range is lesser than selected threshold range, at that time those pixels are noticeable as background. That means the object pixels are represented by one and the background pixels are represented by zero. Next the image is converted to binary format image, which means that two colour image. The image is in white or black depends on pixel value. There are countless procedures and techniques for threshold value selection [25]. Particularly histogram is a promising method. The histogram method accepts that there is certain average rate for the background and object pixels, however that the actual pixel values have specific deviation around these average values.

The next process is image segmentation to find moving vehicle. Generally, image is generally segmented into blobs or regions with certain standard segmentation methods such as background subtraction method, clustering technique and graph cuts approach [26]. Segmented areas are then clustered together to denote an object based on particular deterministic conditions. This paper follows Optical flow method, which is used to find the pattern of motion of vehicles, surfaces, and edges from the video input. In tracking system the information of each frame is read and the background detail is assessed. The undesirable and interested objects are identified by removing the background. This proposed work also follows blob analysis. [27, 28] In the region of computer vision application, blob detection states to visual modules that are intended at sensing points, regions in the frame that vary in properties like brightness or colour compared to the settings.

### III.2 FRAME DIFFERENCING

Frame differencing method is the algorithm has concentrated on the trajectory of movement of the objects. Initially the video stream from the stationary camera and is taken as an input. This video is then decomposed into frames that vary from one frame to another frame. Then the incoming frames are converted to grey scale to avoid unwanted noises. Next Frame-differencing method is used to segregate the moving pixels from stationary pixel in the sequence of frames. The region of interest is identified by the difference of the relative positions of the pixels in the subsequent image frame. The optical flow determines the direction of group of pixels. This is calculated to capture the degree of displacement of the pixel density between the two frames. The flow vectors of the moving object are taken as an input. The morphological operation is used to consolidate the pixel density around the segmented region to avoid the inaccurate detection of false positives and false negatives in the image. The blob analysis is used to detect a two-dimensional shape of an image. This is motion-based method. The main task of blob analysis can eliminate the objects which is not determined as vehicles. The performance of the algorithm mainly depends on the quality of the given input video. This method predicts inappropriate number of vehicles.

### III.3 BACKGROUND AND FOREGROUND SUBTRACTION

Background and foreground Subtraction technique is deliberated to be one of the most reliable methods for moving vehicle finding. Background subtraction works by initializing a background model, then difference between current frame and presumed background model is obtained by comparing each pixel of the current frame with assumed background model colour map. In case difference between colours is more than threshold, pixel is measured to be belonging to foreground. Performance of traditional background subtraction method mainly gets affected when background is dynamic, illumination changes or in presence of shadow. Plentiful approaches have been developed so forth to upgrade background subtraction method and overcome its drawbacks. Different methods of background subtraction are used, they are: Eigen backgrounds, Kernel estimation, Concurrence of image differences, Mixture of Gaussians, Sequential density approximation, Running Gaussian average, and Temporal median filter. Dynamic autoregressive moving average is specially considered for background modelling for the proposed work.

The processing of vehicle object detection is that devising foreground object (vehicle) from background real time from video sequence, i.e. the subtraction of foreground and background. Such object detection is the main part of digital image processing technique, and form the basis of follow up high level processing tasks such as recognition and tracking system. There exist two stages to detect target, they are background subtraction, and finally target extraction. In this system, the input signals are colour video sequences. The useful message is moveable vehicle object. Firstly, we extract background in each frame, then using subtraction with still frame and binarization, we can get movable object image, and this result is object extraction. Generally, the traffic surveillance camera is typically fixed at a certain spot and hence the background is motionless. So, the background subtraction is suitable to be employed to detect the moving vehicles in the process of change detection. Initially, a static background is derived to be a reference frame and then frame-difference technique is used for change detection. In order to achieve the vehicle-flow counting, the proposed method will track each moving vehicle within successive image frames. However, after segmenting moving objects, these objects with their bounding boxes and centroids are extracted from each frame. Also, the area of a vehicle is also considered for the vehicle tracking. For every target in the present frame, target with the lowest distance and same size among two successive frames needs to be examined in the previous frame.

### III.4 SPEED IDENTIFICATION

The speed of the moving vehicle in every frame is founded by using the location of the moving vehicle in every frame; therefore the following stage is to discover the spots by bounding box method. Bubble centroid distance is significant to realize the moving vehicle in consecutive frames and therefore is known as the frame rate for motion capture, the speed calculation becomes possible. The detail statistics must be documented in a continuous array cell in the identical dimension as the camera input frame captured from the video sequence, since the distance moved by the centroid is wanted is a pixel with a particular coordinate on the input frame to conclude the moving vehicle speed. This research work aims to present alternative tactic to evaluate the vehicles velocity. This research work necessitates a video



sequences, including the succeeding mechanisms: moving vehicle opening reference point and end point of reference. Shrinking algorithm is considered to identify the speed of the moving vehicle. The speed of the estimation procedure is associated with the tracking objects in binary variance of input video frames.

This research work grants an innovative and different moving vehicle counting technique based on image video sequence, which comprises moving vehicle recognition, moving vehicle finding, and moving vehicle counting. The detecting, counting and speed estimation consists of the following steps.

- Step 1. Use frame differencing method to separate the input video sequences into separate frames, concentrated on the trajectory of movement of the objects. The video is then decomposed into frames that vary from one frame to another frame.
- Step 2. Apply the particular thresholding value and pre-processing approaches to handle the input. The pre-processing techniques includes grey scale conversion, binarisation, and so on.
- Step 3. Apply the foreground and background subtraction technique, and extract the region of interest, since the Background and foreground Subtraction technique is deliberated to be one of the most reliable methods for moving vehicle finding.
- Step 4. Detect the moving vehicle and count the number of moving vehicle presents in the particular video frame image file.
- Step 5. Use the binary image and separate it into collections of moving objects utilizing the shrinking algorithm to determine the speed of the moving vehicle. And track each in successive frames and discover its spatial bounding box coordinates.

#### IV. EXPERIMENTAL SETUP AND RESULT

Detecting and tracking the moving vehicles in the traffic circumstances during driving are significant characteristics in harmless driving, accident escaping, and spontaneous driving and detection. This planned research paper premeditated a structure that is talented of recognizing vehicles ahead, moving in the similar track as vehicle, by following them continuously with the video sequences from camera. The central problematic issue is to recognise vehicles in fluctuating surroundings and illumination. Even though there have been abundant research work on common moving vehicle recognition and tracking, or a arrangement of them, not numerous of these practices could efficaciously be functional in real time for fining moving vehicle from the video sequences. This research work announces an modern approach to design and implement such real-time oriented algorithms and arrangements that are extremely adaptive to the road and traffic scenes based on domain-specific knowledge on traffic surveillance from the video sequence.

Video is the knowledge of electronically recording, storing, capturing, transmitting, processing, and reconstructing a sequence of still images demonstrating scenes in motion. An image is a rectangular grid of pixels. It has a certain height and a definite width counted in pixels. A video commonly contains of scenes, and every scene contains one or more shots. A shot is an uninterrupted segment of video frame sequence with static or continuous camera motion, while a scene is a series of consecutive shots that are coherent from the narrative point of

view. In this research work, present an effective technique for calculating direction of motion of a vehicle and evaluate its speed.

Moving vehicle detection system is designed for traffic surveillance system using python. The proposed system using the Opencv computer vision frame works. The video is givern as input for the system. The video is converted to separate frames. Reading of frame from a video sequence, Firstly we have taken a video and then read the entire frame in the video. Frame Differencing Frame difference method identifies the existence of moving target by considering the difference among two next frames. The traditional method using the image subtraction operative that gets output image by subtracting second image frame from first image frame in equivalent successive frames. Frame differencing method lacks in obtaining the complete contour of the object as a result of which morphology operations are general used to obtain better results. It is hard to find any difference in continuous two frames. Two consecutive frames are displayed in Figure 3. Taking the difference of the pixel values of two consecutive frames will help us observe the moving objects. Next basic image processing techniques are applied.

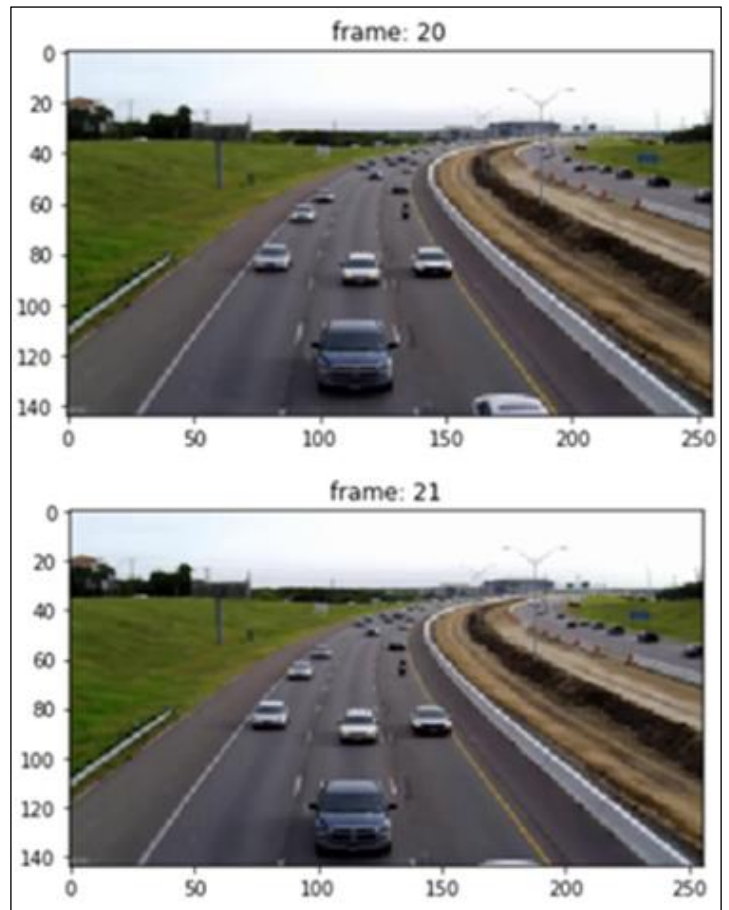

Figure 3: Continuous frames from input video. Source: Authors, (2020).

If the luminance value of a pixel differ significantly from the background image, the pixel is marked as moving object, otherwise, the pixel is regarded as background. Binarisation is applied on this subtraction result and gets moving vehicle objects. For each pixel in the frame, judge the value difference with the corresponding value in background image. If the difference is higher than a threshold, we regard it as foreground and output 1, otherwise as background and output 0. In this way, many situations which may cause trouble in conventional approaches

can be handled properly without using complicated operations. Finally, each 1 or 0 construct a binarisation image and finish object extraction of Vehicle processing. Threshold segmentation method is mainly used in this object extraction stage, after obtaining background image, used background subtraction to obtain the object. In this processing, a proper threshold will have an important impact on object extraction. All the grey pixels is larger than the threshold were fixed to 255, which means white in colour, and all the less than the threshold were fixed to zero in black colour. As the constantly changing of forward image and background image, it cannot use a fixed threshold to split each frame image, so for different images in each frame we must select a most appropriate threshold for segmentation.

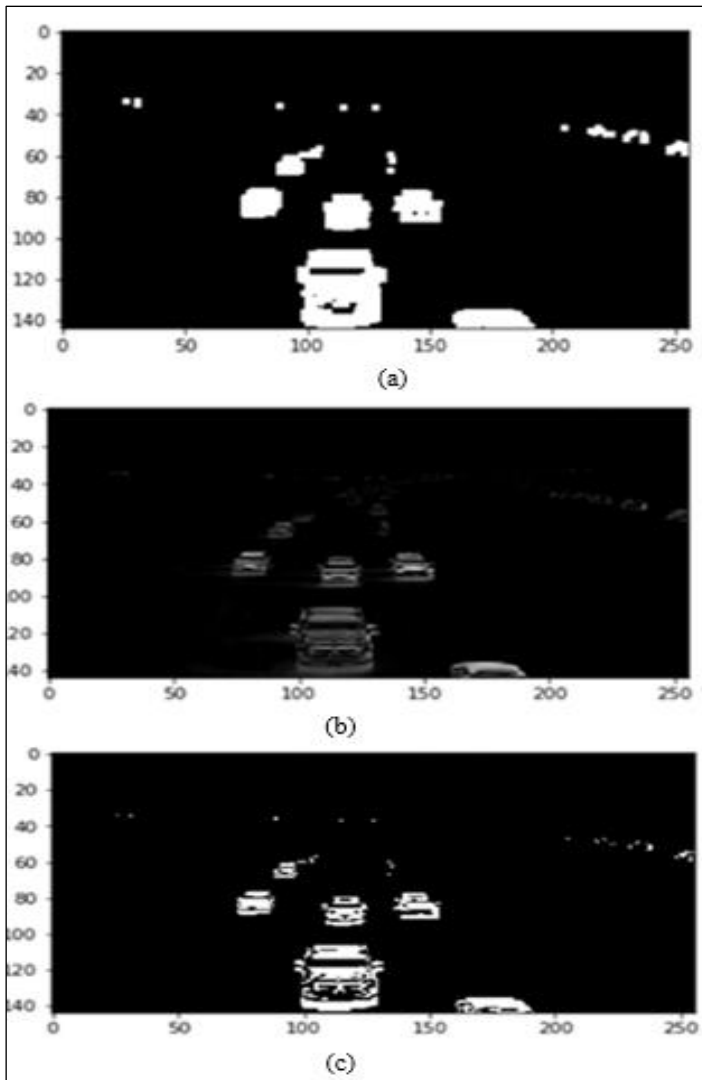

Figure 4: Image processing technique result (a) Grey image (b) Threshold image (c) Dilated image.  
Source: Authors, (2020).

A background reference image is mandatory for background subtraction approach. It will be used to as reference to each fresh frame which will result in the outline of target and their shadows. The system used the initial frame of each video as the background reference image. The Background reference not necessary that it will be first frame of the video sequence but it can be other frames also. The background reference image is put away in variable matrices format which will be utilized in further handling of the image. Normalizing factor of each frame initially extract the background reference from the first frame image.

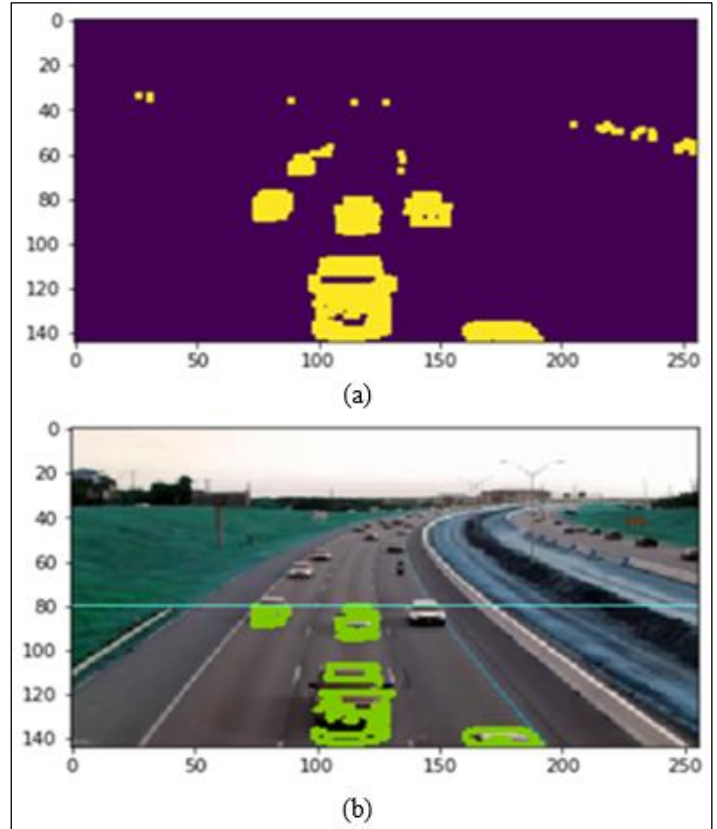

Figure 5: Moving vehicle detection (a) Finding vehicle zone (b) Detect vehicles.  
Source: Authors, (2020).

In any frame, converting an RGB image into normalized image format removes the effect of any intensity variations. Gray scale image has no colour information. It only contains brightness data of the image. By graying, the system converts colourful image which contains brightness and colour information to the one which has only brightness data. Graying is an important step in image processing, whose output is the foundation of subsequent processing. The result of the image processing techniques presented in Figure 4. In the next step, the location of the vehicles are identified. From this able to find vehicles from the zone. Finding vehicle zone is given in Figure 6 for reference. Similarly Figure 5 display the vehicle detection of the proposed model for traffic surveillance system. This research paper provides a unsupervised based technique which provides the number of present vehicle in the frame. And also it gives the location of the moving vehicle in the frame. The moving vehicle count detection is given in Figure 7.



Figure 6: Detecting moving vehicles.  
Source: Authors, (2020).

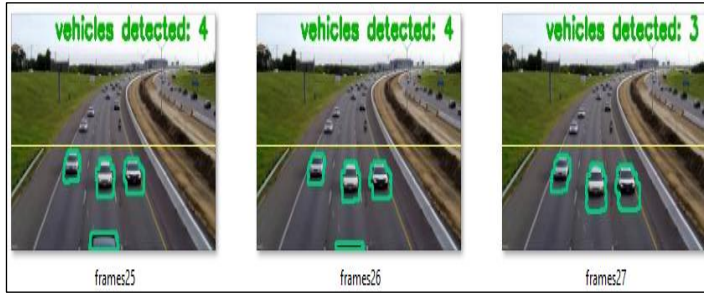

Figure 7: Counting the vehicle number.  
Source: Authors, (2020).

The main aim has been to discover the moving vehicles and subsequently, analyse the speed of that moving vehicles. However previous the research is working with the aim of moving vehicle detection, which includes some important sub process like pre-processing, frame differencing, image segmentation and moving vehicle counting. Additional this research work made a shot to find the speed of the moving vehicle, using the shrinking algorithm method. Even though that it does not produce a very great density of flow vectors, shrinking algorithm is tough in presence of Noise. The speed rate is given in Table 1.

Table 1: Speed rate of detected moving vehicle.

Vehicle number	True speed (Km/h)	Estimated speed (Km/h)	Error (Km/h)
1	71.80	72.63	0.83
2	67.62	68.91	1.29
3	65.86	66.72	0.86
4	73.56	73.99	0.43
5	67.95	68.05	0.1
6	72.57	72.79	0.22
7	69.02	70.21	1.19
8	68.43	69.54	1.11
9	73.55	73.94	0.39
10	71.82	72.94	1.12

Source: Authors, (2020).

## V. CONCLUSION

Computer Vision is an interdisciplinary field concerned with giving computers the ability to see or be able to understand the contents of digital images such as photos and videos. While vision is a trivial task for humans and animals, it's currently quite difficult for machines. However, a lot of progress has been made in the field in the last few decades and new techniques and technologies to make computer vision faster and more accurate are actively being researched. The key importance of the traffic surveillance structure is emerging a arrangement to track the moving vehicle from the traffic video sequences. Tracking the moving vehicle includes the following sub process like background subtraction, counting the number of vehicles. In this study, an efficient moving vehicle tracking from video sequence algorithm is established. A background location image method is used to create reliable background information from the input traffic video sequence. After this, every input frame from video sequence is compared with the background input image. Lastly, a post-processing techniques are used to eliminate the noise regions and produce a more smooth shape boundary. After enhancement, the various methods like conversion from RGB to grey image, binarisation algorithms, thresholding and watershed algorithm are used for the segmentation of the image. From this research, it can be seen in the final output that it is working very good and

accurately. The above algorithms can be used in different applications like moving object tracking, vehicle counter and traffic controlling.

## VI. AUTHOR'S CONTRIBUTION

**Conceptualization:** Jency Rubia J, Babitha Lincy R and Ahmed Thair Al-Heety.

**Methodology:** Jency Rubia J, Babitha Lincy R and Ahmed Thair Al-Heety.

**Investigation:** Babitha Lincy R and Ahmed Thair Al-Heety

**Discussion of results:** Jency Rubia J, Babitha Lincy R and Ahmed Thair Al-Heety.

**Writing – Original Draft:** Jency Rubia J and Babitha Lincy R.

**Writing – Review and Editing:** Babitha Lincy R and Ahmed Thair Al-Heety.

**Resources:** Babitha Lincy R

**Supervision:** Jency Rubia J.

**Approval of the final text:** Jency Rubia J, Babitha Lincy R and Ahmed Thair Al-Heety.

## VII. REFERENCES

- [1] R. Babitha Lincy, Gayathri, R. Optimally configured convolutional neural network for Tamil Handwritten Character Recognition by improved lion optimization model. Multimedia Tools and Application (2020). <https://doi.org/10.1007/s11042-020-09771-z>
- [2] S. Cheung and C. Kamath, Robust Techniques for Background Subtraction in Urban Traffic Video, Video Communications and Image Processing, SPIE Electronic Imaging, San Jose, January 2004.
- [3] B. Qi, M. Ghazal, and A. Amer, "Robust global motion estimation oriented to video object segmentation," IEEE Transactions on Image Processing, vol. 17, no. 6, pp. 958–967, 2008.
- [4] H. Eng, J. Wang, A. Kam, and W. Yau, "Novel Regionbased Modeling for Human Detection within High Dynamic Aquatic Environment," Proceedings on CVPR, 2004.
- [5] Thou-Ho Chen, Jun-Liang Chen, Chin-Hsing Chen and Chao-Ming Chang, "Vehicle Detection and Counting by Using Headlight Information in the Dark Environment" in IEEE 2007 International Conference on Intelligent Information Hiding and Multimedia Signal Processing IHHMSP07, Kaohsiung, Taiwan, Nov. 26-28, 2007. pp. 519-522.
- [6] Surendra Gupte, Osama Masoud, Robert F. K. Martin, and Nikolaos P. Papanikolopoulos, Detection and Classification of Vehicles, in Proc. IEEE Transactions On Intelligent Transportation Systems, Vol. 3, NO. 1, March 2002.
- [7] M. Cristani, M. Bicegi, and V. Murino, "Integrated Region- and Pixel based Approach to Background Modeling", Proceedings of the MOTION, 2002.
- [8] K. P. Karmann and A. von Brandt, "Moving object recognition using an adaptive background memory," in Proc. Time-Varying Image Processing and Moving Object Recognition, vol. 2, V. Capellini, Ed., 1990.
- [9] O. Brouard, F. Delannay, V. Ricordel, and D. Barba, "Spatio-temporal segmentation and regions tracking of high definition video sequences based on a markov random field model," in Proceedings of the IEEE International Conference on Image Processing (ICIP '08), pp. 1552–1555, October 2008.
- [10] N. Kanhere, S. Pundlik, S. Birchfield, Vehicle Segmentation and Tracking from a Low-Angle Off-Axis Camera, IEEE Conference on Computer Vision and Pattern Recognition, San Diego, June 2005.
- [11] H. S. Mohana, Aswatha Kumar and Shiva kumar Malnad College of Engineering, Hassan, Karnataka," Vehicle Counting And Classification Using Kalman Filter And Pixel Scanner Technique And Its Verification With Optical Flow Estimation", Global Journal of Computer Science and Technology 46 Vol. 10 Issue 8 Ver. 1.0 September 2010.
- [12] Vibha L, Chetana Hegde, P Deepa Shenoy, Venugopal K R, L M Patnaik," Dynamic Object Detection, Tracking and Counting in Video Streams for



Multimedia Mining”, IAENG International Journal of Computer Science35:3 IJCS\_35\_3\_16, august 2008.

[13] Neeraj K. Kanhere, Stanley T. Birchfield, Wayne A. Sarasua, Tom C. Whitney, "Real-time detection and tracking of vehicle base fronts for measuring traffic counts and speeds on highways", *Transportation Research Record*, No. 1993. (2007).

[14] A. J. Kun and Z. Vamossy, "Traffic monitoring with computer vision," *Proc. 7th Int. Symp. Applied Machine Intelligence and Informatics (SAMI 2009)*.

[15] P. Wang and H. Qiao, "Online appearance model learning and generation for adaptive visual tracking," *IEEE Transactions on Circuits and Systems for Video Technology*, vol. 21, no. 2, pp. 156–169, 2011.

[16] D. Jansari and S. Parmar, "Novel object detection method based on optical flow," in *Proceedings of the 3rd International Conference on Emerging Trends in Computer and Image Processing (ICETCIP '13)*, Kuala Lumpur, Malaysia, 2013.

[17] M. Vargas, Member, IEEE, S. L. Toral, Senior Member, IEEE ; F. Barrero, Senior Member, IEEE;J.M. Milla, "An Enhanced Background Estimation Algorithmfor Vehicle Detection in Urban Traffic Video", *Proceedings of the 11th International IEEE Conference on Intelligent Transportation Systems Beijing, China, October 12-15, 2008*.

[18] D. Beymer, P. McLauchlan, B. Coifman, and J. Malik, "A real-time computer vision system for measuring traffic parameters," in *Proc. IEEE Conf. Computer Vision and Pattern Recognition, Puerto Rico, June 1997*, pp. 496–501.

[19] E. Sankaralingam, V. Thangaraj, S. Vijayamani, and N. Palaniswamy, "Video compression using multiwavelet and multistage vector quantization," *International Arab Journal of Information Technology*, vol. 6, no. 4, pp. 385–393, 2009.

[20] Jency Rubia, J., Sathish Kumar, G.A.: A high speed fixed-width floating point multiplier using RLNS algorithm. *Int. J. Electr. Eng. Educ.* 1–9 (2018).

[21] T. Senst, V. Eiselein, and T. Sikora, "Robust local optical flow for feature tracking," *IEEE Transactions on Circuits and Systems for Video Technology*, vol. 22, no. 9, pp. 1377–1387, 2012.

[22] Y. Sheikh, O. Javed, and T. Kanade, "Background subtraction for freely moving cameras," in *Proceedings of the IEEE 12th International Conference on Computer Vision*, pp. 1219–1225, Kyoto, Japan, 2009.

[23] Kanhere, Birchfield, Sarasua, Whitney, "Real-Time Detection and Tracking of Vehicle Base Fronts for Measuring Traffic Counts and Speeds on Highways" in *Transportation Research Board Annual Meeting, Washington, D.C., January 2007*. TRB Paper Number: 07-3308.

[24] A. Ghosh, B. N. Subudhi, and S. Ghosh, "Object detection from videos captured by moving camera by fuzzy edge incorporated markov random field and local histogram matching," *IEEE Transactions on Circuits and Systems for Video Technology*, vol. 22, no. 8, pp. 1127–1135, 2012.

[25] K. Kalirajan, M. Sudha, V. Rajeshkumar, and S. S. Jamaesha, "Adaptive visual tracking system using artificial intelligence," in *Proceedings of the IEEE/OSA/IAPR International Conference on Informatics, Electronics and Vision (ICIEV '12)*, pp. 954–957, IEEE, May 2012.

[26] S. Johnson and A. Tews, "Real-time object tracking and classification using a static camera," in *Proceedings of the IEEE International Conference on Robotics and Automation (ICRA '09)*, Kobe, Japan, May 2009.

[27] Jency Rubia J., Babitha Lincy R. (2021) Digital Image Restoration Using Modified Richardson-Lucy Deconvolution Algorithm. In: Chen JZ., Tavares J., Shakya S., Iliyasa A. (eds) *Image Processing and Capsule Networks. ICIPCN 2020. Advances in Intelligent Systems and Computing*, vol 1200. Springer, Cham. [https://doi.org/10.1007/978-3-030-51859-2\\_10](https://doi.org/10.1007/978-3-030-51859-2_10).

[28] M.Sankari and C. Meena, "Adaptive Background Estimation and object detection applying in Automated visual surveillance" (*IJCSIS*) *International Journal of Computer Science and Information Security*, Vol. 8, No. 4, July 2010.





ISSN ONLINE: 2447-0228



### RESEARCH ARTICLE

### OPEN ACCESS

## PREDICTING PROTEIN SECONDARY STRUCTURE BASED ON ENSEMBLE NEURAL NETWORK





Emmanuel Gbenga Dada\*<sup>1</sup>, David Opeoluwa Oyewola<sup>2</sup>, Joseph Hurcha Yakubu<sup>3</sup> and Ayotunde Alaba Fadele<sup>4</sup>

<sup>1</sup> Department of Mathematical Sciences, Faculty of Science, University of Maiduguri, Maiduguri, Nigeria.

<sup>2</sup> Department of Mathematics and Computer Science, Federal University Kashere, Gombe, Nigeria.

<sup>3</sup> Department of Mathematical Sciences, University of Maiduguri, Maiduguri, Nigeria.

<sup>4</sup> Department of Computer Science, Federal College of Education, Zaria, Kaduna State, Nigeria.

<sup>1</sup> <http://orcid.org/0000-0002-1132-5447> , <sup>2</sup> <http://orcid.org/0000-0001-9638-8764> , <sup>3</sup> <http://orcid.org/0000-0003-2168-9882> ,  
<sup>4</sup> <http://orcid.org/0000-0002-1125-0780> 

Email: \*gbengadada@unimaid.edu.ng, davidakaprof01@yahoo.com, hurch65@gmail.com, ayotundefadele@yahoo.com

### ARTICLE INFO

#### Article History

Received: December 14<sup>th</sup>, 2020

Accepted: February 03<sup>th</sup>, 2021

Published: February 15<sup>th</sup>, 2021

#### Keywords:

Protein secondary structure prediction,  
Ensemble Neural Network,  
Feed Forward Neural Network (FFNN),  
Recurrent Neural Network (RNN),  
Cascade Forward Network (CFN).

### ABSTRACT

Protein structure prediction is very vital to innovative process of discovering new medications based on the knowledge of a biological target. It is also useful for scientifically exposing the biological basis of convoluted diseases and drug effects. Despite its usefulness, protein structure is very complex, thereby making its prediction to be arduous, timewasting and costly. These drawbacks necessitated the need to develop more effective techniques with high prediction capability. Conventional techniques for predicting protein structure are ineffective, perform poorly, expensive and slow. The reasons for these are due to the vague dissimilar sequences among protein structures, meaningless protein data, high dimensional data, and having to deal with highly imbalanced classification task. We proposed an Ensemble Neural Network learning model that consists of some Neural Network algorithms such as Feed Forward Neural Network (FFNN), Recurrent Neural Network (RNN), Cascade Forward Network (CFN) and Non-linear Autoregressive Network with Exogenous (NARX) models. These models were trained using training algorithms such as Levenberg-Marquardt (LM), Resilient Back Propagation (RBP) and Scaled Conjugate Gradient (SCG) to improve the performance. Experimental results show that our proposed model has superior performance compared to the other models compared.



Copyright ©2016 by authors and Galileo Institute of Technology and Education of the Amazon (ITEGAM). This work is licensed under the Creative Commons Attribution International License (CC BY 4.0).

### I. INTRODUCTION

It Proteins are sophisticated molecular structures that universally execute the cell to cell routines that are essential to support life. Though the organic proteins have been very playing very remarkable roles, it is only a small percentage of the entire probable amino acid structures that become visible in nature. Bioinformatics which is a collaboration between biology and computer science provides an avenue that allows more comprehensive exploration of protein's sequence space to develop artificial proteins with enhanced robustness and greater usefulness in comparison with their natural equivalents. It is clear from [1, 2] that several protein functions are facilitated by protein-protein interactions (PPIs). Therefore, restructuring their interfaces to

improve or fine-tune the connecting attraction and connecting mode of PPIs is a useful technique to improve the functions of proteins [3]. This method has been used productively to remodel different protein systems [4-8], and has an enormous capacity for the design and implementation of an innovative curative, globular protein and other beneficial proteins.

There are two basic computational techniques for predicting protein secondary structure: template-based approach and machine learning approach. The drawbacks of the template-based approach are that it has lower accuracy compared to a machine learning approach, and performs poorly on non-homologous proteins [9]. Machine learning (ML) usually predict protein structure by first extracting essential features from protein sequences. The shortcoming of this approach is that the extracted features might

not contain all the information that is in a protein sequence. This means that some important information might have been lost [10-12].

On the other hand, from the viewpoint of biology, protein sequence has very important information that enables it to take on specific structures [9, 12, 13]. Even though it is very interesting to predict such structures, serious problems are arising from it. To start with, the complexity of the connection between a sequence and its subsequent structure is a huge disadvantage [14, 15]. Moreover, the chosen features can considerably influence the efficiency of the learner [12]. Another issue is the problem of noise in the training data as well as protein sequences and their associated structures. Finally, there is the problem of class inequality in amino-acid samples as the classes are not evenly distributed [16].

Artificial Neural Networks (ANN) is a major recent advance in machine learning. It possesses the ability to automatically learn to appropriately represent primary data, detect attributes that are above average, enhance effectiveness over conventional models. ANN also improve the understanding of the significance of data and offers further understanding on the composition of biotic data [17]. Motivated by the characteristics of ANN.

This paper proposed an ensemble Neural Network based approach for prediction of protein secondary structure. Our main contributions in this paper are as stated below:

- We developed an ensemble Neural Network learning model that can process hidden contexts of input protein sequences and accurately predict their secondary structures.
- We used four (4) different neural network classifiers and jointly combined the classification results to represent the final results.
- Better classification accuracy of protein secondary structure was achieved through aggregation of ensemble results of Feed forward neural network (FFN), Cascade forward neural network, Recurrent neural network, neural network, and Non-linear autoregressive network with exogenous (NARX).

## II. RELATED WORKS

The Several works have been done in the field of protein structure prediction. The ML based approach are one of the prevalent methods in use for the purpose. There are three popular sets of ML models that have found application for protein sequence-structure mapping. They include: artificial neural networks (ANN), deep learning techniques, and ensemble learners. ANN is the earliest type of ML algorithms that are applied for predicting protein secondary structure. In reality, using an ingenious ANN can accurately predict the boundaries of a class. Experimental results of various research have shown that recurrent neural networks (RNN) [18-20] are very effective for processing protein sequence data. A variant of RNN called bidirectional recurrent neural networks is known to exploit the data of the complete structure. Whereas time is a complex entity that plays a very important role in information retention [21-23]. It has been demonstrated that long temporary RNN possesses the ability to keep data over a long time span [24]. The Convolutional neural network (CNN) is a type of supervised Deep learning algorithm. The CNN is beneficial for predicting protein structure due to its dependable, robust, concurrent processing and self-learning proficiency. The CNN uses additional sequence information in it is learning process and makes allowances for mutuality of the

neighbouring frame of reference [25]. Recently, research in both surface [26, 27] and DNN [28], aggregate the predictions of different networks in an ensemble manner.

An ensemble NN having three deep learning algorithms was developed by [28]. Though neural networks have several advantages, they are characterised with several weaknesses such as difficulty in choosing optima values for parameters like neurons, layers, and activation functions. The implication of this is the negative impact it has on the prediction result. There is also the drawback of the ANN algorithm getting stuck in the local minima.

To overcome these challenges associated with the prediction of the protein secondary structures, we employed an Ensemble Neural Network model that comprises of the following Feed forward neural network, Cascade FFN and RNN. We compared the performance of our proposed model with that of Pattern recognition neural network, NARX and Multilayer Perceptron neural network.

## III. MATERIALS AND METHODS

### III.1 NEURAL NETWORK ALGORITHMS

#### III.1.1 Feed Forward Neural Network (FFNN)

The FFNN is a very popular neural networks. It was developed as a result of the need to develop more efficient artificial neural network that will overcome weaknesses associated with back propagation learning algorithm. The FFNN feeds data from the inputs layers via the hidden layers to the outputs. The basic reason why it is referred to as feed forward network is that it uses forward propagation. The major strength of the FFNN is their ease of implementation and management. This makes them suitable for approximating any type of input and output representation [29]. The effectiveness of FFNN deeply hangs on the tuning of the weights of the nodes. The discrepancy between the result produced by the FFNN and the forecasted output is finalized after every iteration. As the neural network is separated with regard to their nodes, the training process becomes more controllable. The structure and operation of the FFN is in Figure 1.

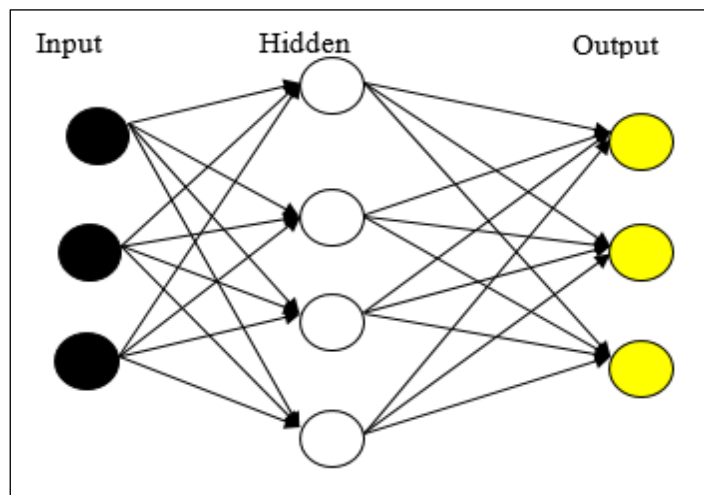

Figure 1: Feed Forward Neural Network.

Source: [29].

The activation function equation of the  $i^{th}$  hidden neuron is given in Equation 1:

$$h_i = f(u_i) = f(\sum_{k=0}^K w_{ki}x_k) \quad (1)$$

Where  $h_i$  is the  $i^{th}$  hidden neuron,  $f(u_i)$  is the connection function that ensures that the outcome does not change in proportion to a change in any of the inputs among input and hidden layers,  $w_{ki}$  is the weight in the  $ki^{th}$  entry in a  $(K \times N)$  weight matrix,  $x_k$  is the  $K$  input value.

$$y_j = f(u_j^1) = f(\sum_{i=1}^N w_{ij}h_i) \quad (2)$$

Where  $y_j$  is the  $j^{th}$  output value.

### III.1.2 Cascade Forward Network

The cascade forward network (CFN) neural networks have some similarities with the FFNN because they also use back propagation algorithm for updating weights. The main difference is that they are made up of a weighted connection to the input of individual level as well as across one level to the successive levels [30]. It was opined that some cascade forward back propagation network can have superior performance compared to FFNN in many cases [31]. One of the striking characteristics of this network is that individual layer of neurons is connected to the entire preceding layer of neurons [32]. The pictorial depiction of CFN is in Figure 2.

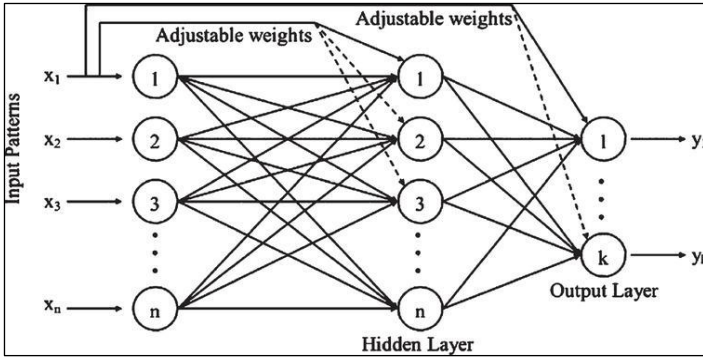

Figure 2: Cascade Forward Network. Source: [32].

The mathematical equation for CFN is stated as:

$$y = \sum_{i=1}^n f^i(w_i x_i) + f^o(\sum_{j=1}^k w_j^o f_j^h(\sum_{i=1}^n w_{ji}^h x_i)) \quad (3)$$

The activation function from the input layer to the output layer is represented as  $f^i$ , while the weight from the input layer to the output layer is  $w_i^i$ . In a situation where bias is combined with the input layer, the activation function of each neuron in the hidden layer is represented as  $f^h$  so equation (3) can be expressed as:

$$y = \sum_{i=1}^n f^i(w_i x_i) + f^o(w^b + \sum_{j=1}^k w_j^o f_j^h(w_j^b + \sum_{i=1}^n w_{ji}^h x_i)) \quad (4)$$

### III.1.3 Recurrent Neural Network (RNN)

RNN is distinctive for its extra set of responses from the generated result of layer that is concealed in between input and output layers. This layer constitutes the context layer that preserves data among observations [33]. The result of processing in a preceding phase can be carried over and used in the current period phase. This important attribute of the RNN offers a tremendously significant advantage, especially in real-time applications. RNN can have an unrestricted memory level and can therefore learn connections through time in addition to learning via the all current possible inputs [34, 35]. The RNN is depicted in Figure 3.

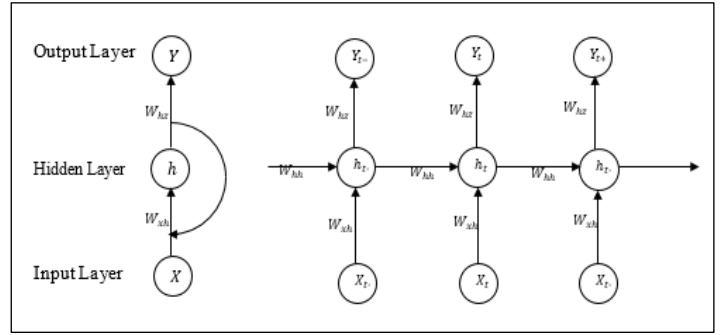

Figure 3: RNN Architecture. Source: [33].

Input to hidden layer is expressed as in Equation 5 as:

$$h_t = g_n(W_{xh}X_t + W_{hh}h_{t-1} + b_h) \quad (5)$$

Here  $h_t$  is the hidden layer at the instance  $t^{th}$ , moreover,  $g_n$  is the function,  $W_{xh}$  is the input to hidden layer of weight matrix, and  $X_t$  is the input at instance  $t^{th}$ . Also,  $h_{t-1}$  is the hidden layer at instance  $t - 1$ , and the bias or threshold value is represented by  $b_h$ . Equation 6 which represents the hidden to output layer is stated as:

$$Z_t = g_n(W_{hz}h_t + b_z) \quad (6)$$

Where the output vector is represented as  $Z_t$ , the hidden to output layer weight matrix is  $W_{hz}$ , and  $b_z$  is the bias or threshold.

### III.1.4 Multi-Layer Perceptron Neural Networks

Multi-layer perceptron (MLP) It is made up of many perceptrons. MLP comprises of an input layer that accepts data, an output layer which generates results or prediction as regards the input, and in the middle of those two, there exist a set of random hidden layers that serves as the real computational engine of the MLP. The MLPs with one hidden layer is capable of estimating any function that is continuous at every value in an interval. Equation 7 expresses the rule used in updating the parameters  $(w_n, b_n)$ :

$$w_{n+1} = w_n + cx \quad b_{n+1} = b_n + c \quad (7)$$

The condition for halting the algorithm is that a function that accepts a dataset as input and produces a decision as output that correctly categorizes the whole training datasets to various classes must be found [37]. Figure 4 below depicts a diagrammatical representation of MLP Neural Networks.

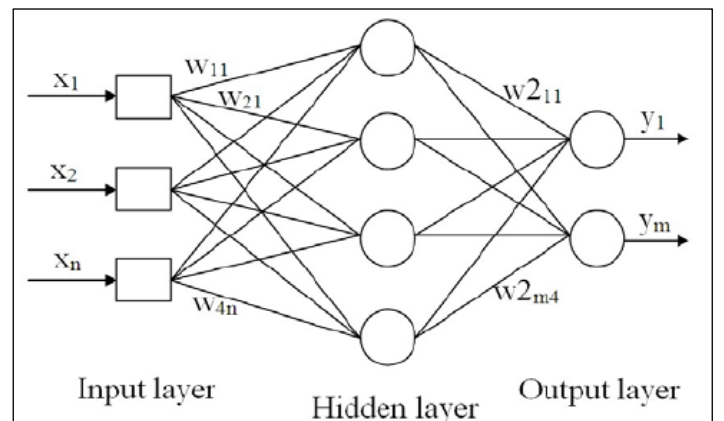

Figure 4: MLP Neural Networks Architecture. Source: [37].

### III.1.5 Non-linear Autoregressive (NARX) Network with Exogenous

Non-linear autoregressive (NARX) neural network is regarded as a classic time series predictor [38-40]. The idea behind NARX is a nonlinear overview of the Autoregressive Exogenous (ARX) that is categorized as a yardstick tool in linear system detection where the most important thing is fitting the data irrespective of the mathematical makeup of the model [41]. One of the major strength of the NARX models is their ability to model a wide-ranging array of nonlinear dynamic systems. They have used for solving many time-series modelling problems [42]. They are considered as a recurrent dynamic neural network with feedback connections that encircle many layers of the network [43]. It is necessary to fully exploit the NARX neural network memory capacity using the previous values of forecasted or actual time series. This will make the NARX neural network to have its optimal performance. Figure 5 depicts the architecture of the NARX.

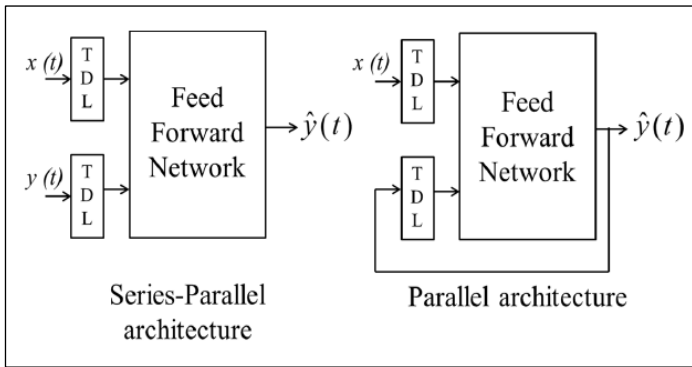

Figure 5: NARX neural network Architecture.  
Source: [39].

## III.2 NEURAL NETWORK TRAINING ALGORITHMS

In this paper three training algorithms namely: LM, SCG, and RBP were used. Description of these algorithms is done in this section. The Training Algorithms is used for weighting adjustments of RNN, CFN and FFN model used in this research.

### III.2.1 Levenberg Marquardt (LM)

LM is a highly effective technique for weights adjustment. It is the fusion of the gradient descent rule and the Gauss-Newton technique. LM determines the step size using a parameter that accepts big values for the initial iterations (the same as that of the Gradient Descent algorithm), and small values in the later phases (like what is obtainable in Gauss-Newton technique). The LM is a fusion of the strengths of both techniques. This makes it start converging from any early-stage like the Gradient Descent method. It also has quick convergence close to the neighbourhood of the least error the same way the Gauss-Newton method behaves. The LM technique however overcomes the weaknesses that are exhibited by both the Gradient Descent algorithm and Gauss-Newton technique [44, 45]. The Levenberg-Marquardt algorithm with vector of unknown parameters which are decided during step  $K + 1$  is represented by Equation 8:

$$x_{k+1} = x_k^T - [J^T(x_k, t)J(x_k, t) + \mu_k I]^{-1} J^T(x_k, t)y(x_k, t) \quad (8)$$

LM with error is denoted by Equation 9:

$$I_2 = \int_0^T y^2(x_k, t) dt \quad (9)$$

Where:

$$y(x_k, t) = \int_0^t k(t - \tau)u(\tau) d\tau \quad (10)$$

$$J(a_k, t) = \begin{bmatrix} \frac{\partial y(x_k, t_1)}{\partial x_1} & \frac{\partial y(x_k, t_1)}{\partial x_2} & \dots & \frac{\partial y(x_k, t_1)}{\partial x_m} \\ \vdots & \vdots & \ddots & \vdots \\ \frac{\partial y(x_k, t_n)}{\partial x_1} & \dots & \dots & \frac{\partial y(x_k, t_n)}{\partial x_m} \end{bmatrix} \quad (11)$$

Assuming:

$k = 1, 2, \dots, p$ ;  $p$  represents the number of iteration loops;  $J_{n \times m}$  is the Jacobian matrix;  $I_{m \times n}$  is the unit matrix;  $\mu_k$  is the scalar and its value changes during iteration;  $x = [x_1, x_2, \dots, x_m]$  is the model parameters searched for.

In situations where the parameters of the vector are not the best ones, and the value of error (8) is not at the lowest level. In such circumstance:

$$J^T(x_k, t)J(x_k, t) \ll \mu_k I \quad (12)$$

Can be taken and this results in the Gradient Descent technique which results in equation 15:

$$x_{k+1} = x_k^T - \frac{1}{\mu_k} J^T(x_k, t)y(x_k, t) \quad (13)$$

If the value of coefficient  $\mu_k$  is small, it denotes that the values of the parameters of vector  $x$  are close to the best solution. At this instant:

$$J^T(x_k, t)J(x_k, t) \gg \mu_k I \quad (14)$$

Indicated that the LM algorithm is condensed to the Gauss-Newton method:

$$x_{k+1} = x_k^T - [J^T(x_k, t)J(x_k, t)]^{-1} J^T(x_k, t)y(x_k, t) \quad (15)$$

Computation of the Jacobian  $J$  regarding the weight and bias variables  $x$  is done using Backpropagation. The tuning of the variables is done according to Levenberg-Marquardt.

### III.2.2 Resilient Back Propagation (RBP)

The RBP was first proposed by [46]. It is a supervised learning method that learns from the entire training dataset at once in FFN. The primary goal of the RBP is to eradicate the negative outcome of the volume of the partial derivative on the weight step. The aftermath of this is that the sign of the derivative is the only factor taken into account to specify the path through which the weight will be updated [46].

When the weight update is done using back propagation, the weight update is decided through the partial derivative expressed in equation 16:

$$\Delta_{wij}(t) = \alpha \times x_i(t) \times \delta_j(t) \quad (16)$$

Assuming  $\alpha$  is the learning rate,  $x_i(t)$  depict the propagation of inputs backwards to the  $i^{th}$  neuron at time step  $t$ , and  $\delta$  is the equivalent error gradient. Unlike the RBP, Resilient propagation computes a distinctive delta  $\Delta_{ij}$  for every connection. This plays a determining factor in choosing the magnitude of the



weight update. The reader can consult Riedmiller [45] for a detailed explanation on the RBP algorithm.

### III.2.3 Scaled Conjugate Gradient (SCG)

SCG algorithm was proposed by [47, 48]. SCG is a variant of conjugate gradient technique developed to lower the running time by employing LM algorithm to increase the step size of the line search for each learning iteration [44]. Through the step size scaling system, this technique circumvents the timewasting and inefficient line-search that characterized each learning iteration. SCG can effectively handle wide-ranging problems. It has proven over time to be very effective at handling training Feed Forward Neural networks and other oversized networks. According to Martin

[50], SCG algorithm was derived from quadratic reduction of objective function E within N iterations to the lowest possible level.

### III.3 PROPOSED ENSEMBLE NEURAL NETWORK TECHNIQUE

We employed four (4) variants of ANN classifiers (FFNN, RNN, CFN and NARX) as base learners and Random Forest (RF) was used as the top layer of our proposed model. Due to the complexity of protein structure, we integrate all the optimal outputs produced by FFNN, RNN, CFN and NARX after they were trained using LM, RBP and SCG. Figure 6 shows the architecture of the proposed Ensemble ANN.

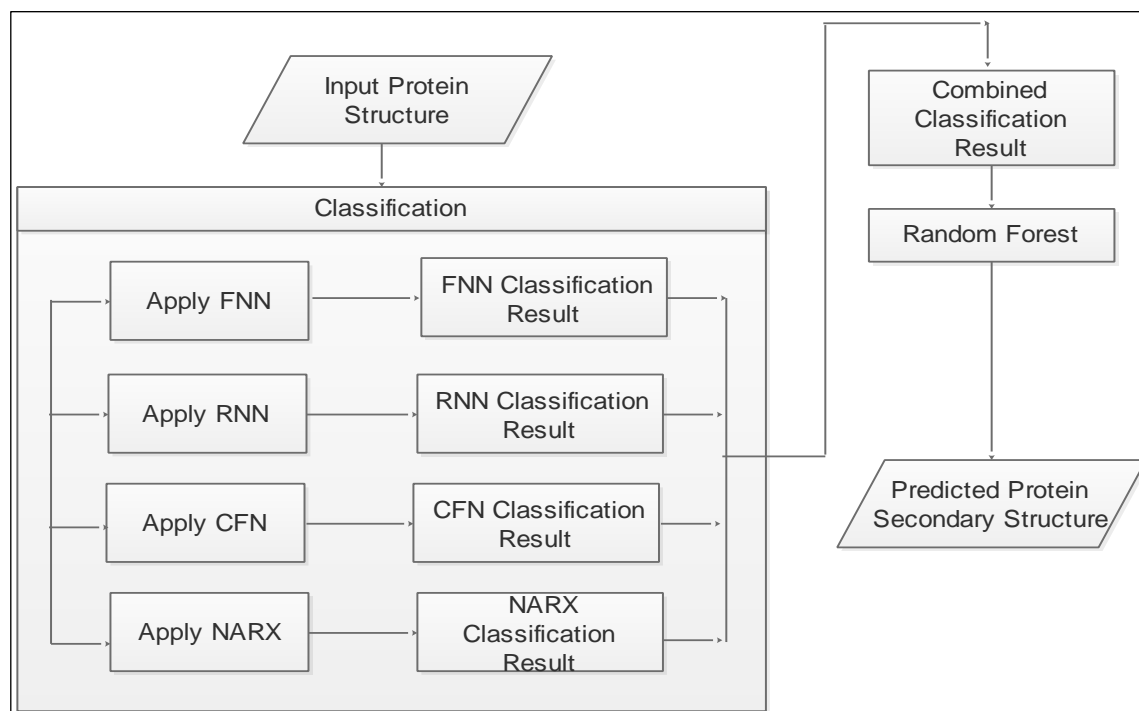

Figure 6: Proposed Ensemble ANN.  
Source: Authors, (2020).

In the proposed ensemble technique, the protein sequence is fed into each of the Neural Network algorithms in the learning stage. The output is regarded as the aggregated classification result of all the learning Neural Networks (FNN, RNN, CFN and NARX) which is used for the final prediction.

## IV. RESULTS AND DISCUSSIONS

### IV.1 EXPERIMENTAL SETUP

The dataset used for the experiments conducted in this work was obtained from the repository of Research Collaboratory for Structural Bioinformatics (RCSB) Protein Data Bank (PDB). The dataset is made up of several kinds of macromolecules of biological importance. A great part of the dataset is protein. Since the antecedent of DNA is RNA that can be converted, it therefore means that proteins are the biomolecules that are immediately interacting in biological routes and progressions. The repository contains over 400,000 annotated protein structures sequences which are publicly available at <https://github.com/iamdebanjangoswami/Predictive-Protein-classification--Naive-Bayes-Classifer>. All the simulation for this work was done using MATLAB 2018 version.

### IV.2 PERFORMANCE METRICS

We evaluate the prediction performance of the ensemble ANN using three metrics: Mean Absolute Error (MAE), Root Mean Square Error (RMSE) and Mean Absolute Scaled Error (MASE).

#### IV.2.1 Mean Absolute Error (MAE)

MAE is defined as the average of the difference between predicted and actual values in the test.

#### IV.2.2 Root Mean Square Error (RMSE)

RMSE is defined as the standard deviation of prediction errors in a test.

#### IV.2.3 Mean Absolute Scaled Error (MASE)

MASE is defined as is a measure of the accuracy of predictions. It is a scale-free error metric that gives each error as a percentage in comparison to a standard mean error.

### IV.3 RESULT AND DISCUSSION

This section describes the statistical results of our simulations. The ensemble ANN was employed to classify and predict the protein sequence structure in the dataset. The dataset was divided into a training set (60%) and test set (40%). The individual classifiers were used to train the dataset. The proposed ensemble ANN produced a classification accuracy of 99.48%. Table 1 shows the simulation results of our proposed model in comparison with some models.

Table 1: Performance evaluation of models based on MAE, RMSE, MASE and Percentage Accuracy.

Model	MAE	RMSE	MASE	% Accuracy
FFN	0.04416	0.14632	1.1998	97.7454
CFN	0.03494	0.09252	0.9493	98.0573
RNN	0.04459	0.14593	1.2115	97.7447
PRNN	0.04302	0.14646	1.1688	97.7440
NARX	0.04902	0.14447	1.3318	97.7454
MLP	0.02254	0.15012	0.6124	97.7400
<b>Ensemble NN</b>	<b>0.01352</b>	<b>0.0108</b>	<b>0.4108</b>	<b>99.4800</b>

Source: Authors, (2020).

The comparison of accuracy for the different models considered in this paper is depicted in Figure 7 while the accuracy is presented in percentage in Figure 8.

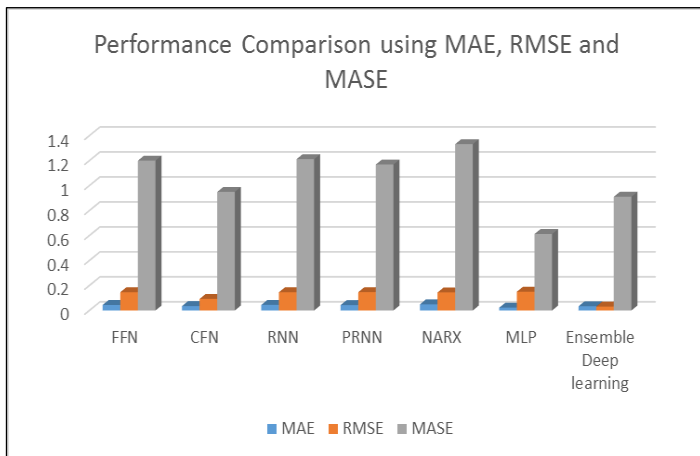

Figure 7: Comparison of models based on Classification Accuracy.

Source: Authors, (2020).

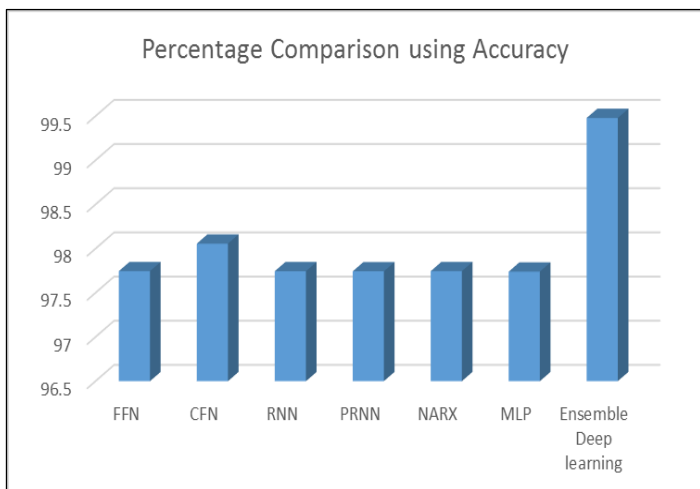

Figure 8: Performance Comparison of models using Percentage Accuracy.

Source: Authors, (2020).

Depicted in Table 2 is the confusion matrix of the various algorithms under consideration.

Table 2: Confusion Matrix.

Model	DNA	Protein	Class
FFN	0	0	DNA
	3188	138213	Protein
CFN	1036	595	DNA
	2152	137618	Protein
RNN	0	1	DNA
	3188	138212	Protein
PRNN	0	2	DNA
	3188	138211	Protein
NARX	0	0	DNA
	3188	138213	Protein
MLP	1	1	DNA
	3187	138212	Protein
<b>Ensemble NN</b>	<b>2872</b>	<b>422</b>	<b>DNA</b>
	<b>315</b>	<b>137791</b>	<b>Protein</b>

Source: Authors, (2020).

From Table 2, it is easy to draw a comparison between the actual class and predicted results. Ensemble accurately predicts 140663 instances out of 141400 instances (2872 DNA instances that are truly DNA and 137791 protein instance that are protein). And 737 instances wrongly predicted (422 instances of DNA class predicted as protein and 315 instances of protein class predicted as DNA). This explains why Ensemble produced superior prediction accuracy compared to other Neural Network models under consideration. From our experiments, it is obvious that Ensemble have superior performance in term of effectiveness and efficiency considering its classification accuracy and MASE.

### V. CONCLUSIONS

An Ensemble ANN model for predicting protein secondary structure is proposed in this paper. The proposed model integrated different Neural Network algorithms for an enhanced predictive accuracy. The three ANN used are FFNN, RNN and CFN. Our statistical results show clearly that our model produced superior results compared to other six models compared. It can therefore be deduced that it is better to predict protein secondary structure by means of the fusion of different ANN rather than using the models alone. In the future, we hope to perform experiment with deep learning architectures and compared it is performance with the ensemble algorithm propose in this work. Also we intend to Extend this research by using moth flame optimisation, particle swarm optimization, grey wolf optimisation, genetic algorithms and others.

### VI. AUTHOR'S CONTRIBUTION

**Conceptualization:** Emmanuel Gbenga Dada.

**Methodology:** Emmanuel Gbenga Dada, David Opeoluwa Oyewola and Joseph Hurcha Yakubu.

**Investigation:** Emmanuel Gbenga Dada and Ayotunde Alaba Fadele.

**Discussion of results:** Emmanuel Gbenga Dada, David Opeoluwa Oyewola and Joseph Hurcha Yakubu.

**Writing – Original Draft:** Emmanuel Gbenga Dada and David Opeoluwa Oyewola.

**Writing – Review and Editing:** Emmanuel Gbenga Dada, David Opeoluwa Oyewola, Joseph Hurcha Yakubu and Ayotunde Alaba Fadele.

**Resources:** Emmanuel Gbenga Dada and David Opeoluwa Oyewola.

**Supervision:** Emmanuel Gbenga Dada and David Opeoluwa Oyewola.

**Approval of the final text:** Emmanuel Gbenga Dada, David Opeoluwa Oyewola, Joseph Hurcha Yakubu and Ayotunde Alaba Fadele.

## VIII. REFERENCES

- [1] H. Jeong, S.P. Mason, A.L. Barabási and Z.N. Oltvai. "Lethality and centrality in protein networks". *Nature*, 411(6833), 2001, pp.41-42.
- [2] A. Szilagy, V. Grimm, A.K. Arakaki and J. Skolnick. "Prediction of physical protein-protein interactions." *Physical biology*, 2(2), 2005, p.S1.
- [3] J. Karanicolas, and B. Kuhlman, "Computational design of affinity and specificity at protein-protein interfaces," *Curr. Opin. Struct. Biol.* 19 (2009), 458-463.
- [4] A. Chevalier, D.A. Silva, G.J. Rocklin, D.R. Hicks, R. Vergara, P. Murapa, S.M. Bernard, L. Zhang, K.H. Lam, G. Yao and C.D. Bahl, "Massively parallel de novo protein design for targeted therapeutics." *Nature*, 550 (7674), 2017, pp.74-79.
- [5] G. Grigoryan, A.W. Reinke, A.E. Keating, "Design of protein interaction specificity gives selective bZIP-binding peptides", *Nature* 458, 2009, 859-864.
- [6] S.J. Fleishman, T.A. Whitehead, D.C. Ekiert, C. Dreyfus, J.E. Corn, E.M. Strauch, I.A. Wilson and D. Baker. "Computational design of proteins targeting the conserved stem region of influenza hemagglutinin". *Science*, 332(6031), 2011, pp.816-821.
- [7] N.P. King, W. Sheffler, M.R. Sawaya, B.S. Vollmar, J.P. Sumida, I. André, T. Gonen, T.O. Yeates and D. Baker. "Computational design of self-assembling protein nanomaterials with atomic level accuracy". *Science*, 336(6085), 2012, pp.1171-1174.
- [8] D. Shultis, P. Mitra, X. Huang, J. Johnson, N.A. Khattak, F. Gray, C. Piper, J. Czajka, L. Hansen, B. Wan and K. Chinnaswamy. "Changing the apoptosis pathway through evolutionary protein design". *Journal of molecular biology*, 431(4), 2019, pp.825-841.
- [9] H. N. Lin, T.Y. Sung, S.Y. Ho and W.L. Hsu, "Improving protein secondary structure prediction based on short subsequences with local structure similarity", *Bmc Genomics*, vol. 11, 2010, p. S4 BioMed Central.
- [10] Y. Chen, "Long sequence feature extraction based on deep learning neural network for protein secondary structure prediction", *Information Technology and Mechatronics Engineering Conference (ITOEC)*, IEEE, 2017, pp. 843-847 2017 IEEE 3rd.
- [11] Z. Li, J. Wang, S. Zhang, Q. Zhang, and W. Wu, "A new hybrid coding for protein secondary structure prediction based on primary structure similarity", *Gene*, 618, 2017, pp. 8-13.
- [12] T. Liu, X. Zheng and J. Wang, "Prediction of protein structural class using a complexity based distance measure", *Amino Acids*, 38 (3), 2010, pp. 721-728.
- [13] Y. Liu, J. Cheng, Y. Ma and Y. Chen, "Protein secondary structure prediction based on two dimensional deep convolutional neural networks", *3rd IEEE International Conference on Computer and Communications (ICCC)*, IEEE, 2017, pp. 1995-1999.
- [14] E. Krissinel, "On the relationship between sequence and structure similarities in proteomics", *Bioinformatics*, 23 (6), 2007, pp. 717-723.
- [15] S. Wang, J. Peng, J. Ma and J. Xu, "Protein secondary structure prediction using deep convolutional neural fields", *Scientific reports*, 6(1), 2016, pp.1-11.
- [16] M. Alirezaee, A. Dehzangi and E. Mansoori, "Ensemble of neural networks to solve class imbalance problem of protein secondary structure prediction", *International Journal of Artificial Intelligence & Applications*, 3 (6), 2012, pp. 9.
- [17] E.G. Dada, J.S. Bassi, H. Chiroma, M.A. Shafi'i, A.O. Adetunmbi, and O.E. Ajibuwa, "Machine learning for email spam filtering: review, approaches and open research problems". *Heliyon*, 5(6), 2019, p.e01802.
- [18] S. Babaei, A. Geranmayeh, S.A. Seyyedsalehi, "Towards designing modular recurrent neural networks in learning protein secondary structures", *Expert Syst. Appl.* 39 (6), 2012, pp. 6263-6274
- [19] F. Masulli, S. Mitra, "Natural computing methods in bioinformatics: a survey", *Inf. Fusion* 10 (3), 2009, pp. 211-216.
- [20] G. Pollastri, A.J.M. Martin, C. Mooney, A. Vullo, "Accurate prediction of protein secondary structure and solvent accessibility by consensus combiners of sequence and structure information", *BMC Bioinf.* 8 (1), 2007, p. 201.
- [21] S. Hosseini, H. Yin, N.M. Cheung, K.P. Leng, Y. Elovici and X. Zhou. "Exploiting reshaping subgraphs from bilateral propagation graphs." In *International Conference on Database Systems for Advanced Applications*, 2018, (pp. 342-351). Springer, Cham.
- [22] S. Hosseini, H. Yin, M. Zhang, X. Zhou and S. Sadiq, "Jointly modeling heterogeneous temporal properties in location recommendation", *International Conference on Database Systems for Advanced Applications*, Springer, 2017, pp. 490-506.
- [23] S. Hosseini, H. Yin, X. Zhou, S. Sadiq, M.R. Kangavari, N.M. Cheung, "Mining subgraphs from propagation networks through temporal dynamic analysis." In *2018 19th IEEE International Conference on Mobile Data Management (MDM) 2018*, (pp. 66-75). IEEE.
- [24] K. Paliwal, J. Lyons, R. Heffernan, "A short review of deep learning neural networks in protein structure prediction problems", *Advanced Techniques in Biology & Medicine*, 2015, pp. 1-2.
- [25] J. Zhou and O.G. Troyanskaya "Deep supervised and convolutional generative stochastic network for protein secondary structure prediction." 2014, arXiv preprint arXiv:1403.1347.
- [26] L. Khalatbari and M.R. Kangavari, "Protein secondary structure prediction: a literature review with focus on machine learning approaches." *Journal of Computer & Robotics*, 8(1), 2015, pp.9-24.
- [27] G. Wang, Y. Zhao, and D. Wang, "A protein secondary structure prediction framework based on the extreme learning machine", *Neurocomputing* 72 (1-3), 2008, pp. 262-268.
- [28] M. Spencer, J. Eickholt and J. Cheng, "A deep learning network approach to ab initio protein secondary structure prediction", *IEEE ACM Trans. Comput. Biol. Bioinform* 12 (1), 2015, pp. 103-112.
- [29] K., M. Hornik Stinchcombe and H. White. "Multilayer feedforward networks are universal approximators." *Neural Networks*, 2(5), 1989, pp. 359-366.
- [30] M. Lashkarbolooki and Z.S. Shafipour, "Trainable cascade-forward back-propagation network modeling of spearmint oil extraction in a packed bed using SC-CO<sub>2</sub>". *The Journal of Supercritical Fluids*, 73, 2012, pp. 108-115.
- [31] U.B. Filik and M. Kurban. "A new approach for the short-term load forecasting with autoregressive and artificial neural network models." *International Journal of Computational Intelligence Research*, 3(1), 2007, pp. 66-71.
- [32] H. Demuth, M. Beale and M. Hagan. "Neural Network Toolbox User's Guide". The MathWorks, Inc., Natick, USA. 2009.
- [33] M. Lashkarbolooki, B. Vaferi, A. Shariati, and A.Z. Hezave. "Investigating vapor-liquid equilibria of binary mixtures containing supercritical or near-critical carbon dioxide and a cyclic compound using cascade neural network". *Fluid Phase Equilibria*, 343, 2013, pp.24-29.
- [34] B.K. Chauhan, A. Sharma and M. Hanmandlu. "August. Neuro-Fuzzy Approach Based Short Term Electric Load Forecasting". In *2005 IEEE/PES Transmission & Distribution Conference & Exposition: Asia and Pacific*, 2005, (pp. 1-5). IEEE.
- [35] H. Demuth, M. Beale and M.Hagan (2009). "Neural Network Toolbox User's Guide". The MathWorks, Inc., Natick, USA. 2009.
- [36] J.L. Elman "Finding structure in time". *Cognitive Science*, 14(2), 1990, pp. 179-211.
- [37] S. Haykin. "Neural Networks: A Comprehensive Foundation". 2nd ed. New Jersey: Prentice Hall., 1999, p. 823.
- [38] H. Jia "Investigation into the effectiveness of long short term memory networks for stock price prediction". arXiv preprint arXiv , 2016, 1603.07893
- [39] M. Awad and M. Foqaha. "Email Spam Classification Using Hybrid Approach of RBF Neural Network and Particle Swarm Optimization." *International Journal of Network Security and its Applications*, Vol. 8, no. 4, 2016, pp. 17-28.

- [40] O.A. Carpinteiro, I. Lima, J.M. Assis, A.C.Z. de Souza, E.M. Moreira, and C.A. Pinheiro, "A neural model in anti-spam systems". In International Conference on Artificial Neural Networks, 2006, (pp. 847-855). Springer, Berlin, Heidelberg.
- [41] S. Mohanty, P.K. Patra, and S.S. Sahoo. "Prediction of global solar radiation using nonlinear autoregressive network with exogenous inputs (narx)". In Proceedings of the 39th National System Conference (NSC), Noida, India, 14–16 December 2015.
- [42] E. Pisoni, M. Farina, C. Carnevale, and L. Piroddi, "Forecasting peak air pollution levels using NARX models." *Eng. Appl. Artif. Intell.* 2009, 22, pp. 593–602.
- [43] L.G.B. Ruiz, M.P. Cuéllar, M.D. Calvo-Flores, and M.D.C.P. Jiménez, "An Application of Non-Linear Autoregressive Neural Networks to Predict Energy Consumption in Public Buildings". *Energies*, 2016, 9, 684.
- [44] K. Levenberg, "A Method for the Solution of Certain Non-Linear Problems in Least Squares." *The Quarterly of Applied Mathematics*. 2, 1944, pp. 164-168.
- [45] D. Marquardt, "An algorithm for least-squares estimation of nonlinear parameters", *SIAM J. Appl. Math.*, Vol. 11, 1963, pp. 431–441.
- [46] M. Riedmiller, "Untersuchungen zu konvergenz und generalisierungsverhalten überwachter lernverfahren mit dem SNNS". In Proceedings of the SNNS 1993 workshop.
- [47] M.F. Møller, A scaled conjugate gradient algorithm for fast supervised learning. Aarhus University, 1990, Computer Science Department.
- [48] C. Tran, A. Abraham and L. Jain "Decision support systems using hybrid neurocomputing". *Neurocomputing*, 61, 2004, pp.85-97.
- [49] M. Riedmiller and H. Braun. "Rprop: A fast adaptive learning algorithm." In Proc. of the Int. Symposium on Computer and Information Science VII. 1992.
- [50] J.T. Wei, Z. Zhang, S.D. Barnhill, K.R. Madyastha, H. Zhang, and J.E. Oesterling. "Understanding artificial neural networks and exploring their potential applications for the practicing urologist". *Urology*, 52(2), 1998, pp.161-172.





ISSN ONLINE: 2447-0228

## ITEGAM-JETIA

Manaus, v.7 n.27, p. 57-62. Jan/Feb, 2021  
DOI: <https://doi.org/10.5935/jetia.v7i27.734>

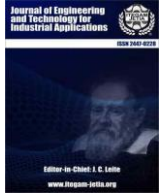

RESEARCH ARTICLE

OPEN ACCESS

## THE ANALYSIS OF THE RECENT PERIODS OF WHEAT MARKET IN TURKEY

Mehmet Caçelik<sup>1</sup>, Zeliha Şahin<sup>2</sup>, Mehmet Reşit Sevinç\*<sup>3</sup>, Nihat Küçük<sup>4</sup> and Mustafa Hakkı Aydoğdu<sup>5</sup>

<sup>1</sup> Department of Social Science Vocational School, Harran University. Şanlıurfa, Turkey.

<sup>2,5</sup> Department of Agricultural Economics, Faculty of Agriculture, Harran University. Şanlıurfa, Turkey.

<sup>3</sup> Department of Bozova Vocational School, Harran University. Şanlıurfa, Turkey.

<sup>4</sup> Department of Economic Policy, Faculty of Economics and Administrative Sciences, Harran University. Şanlıurfa, Turkey.

<sup>1</sup> <http://orcid.org/0000-0001-8158-4455> , <sup>2</sup> <http://orcid.org/0000-0002-9063-4474> , <sup>3</sup> <http://orcid.org/0000-0002-0617-7822> ,

<sup>4</sup> <http://orcid.org/0000-0002-1483-0422> , <sup>5</sup> <http://orcid.org/0000-0002-4945-5239> 

Email: m.cancelik@harran.edu.tr, zelihasahiin@gmail.com, \*rsevinc@harran.edu.tr, nihatk@harran.edu.tr, mhaydogdu@hotmail.com

### ARTICLE INFO

#### Article History

Received: December 20<sup>th</sup>, 2020

Accepted: January 28<sup>th</sup>, 2021

Published: February 15<sup>th</sup>, 2021

#### Keywords:

Consumption,  
Prices,  
Wheat production,  
Trade balance,  
Turkey.

### ABSTRACT

The issue of food safety is a concern due to the climate change that has become more frequent globally. Wheat has special importance among the basic food sources of living things. Although Turkey to take place within the first 10 countries in the world wheat area, the amount of production is low. The research aims to analyze consumption, yield, average selling price, export-import value, foreign trade balance, and the trend of these for the near future of wheat production in Turkey. For this purpose, projections were made until 2024 by using data between the years of 2005 and 2019. According to the results, the wheat cultivation areas decrease, and prices are rising in Turkey. On the other hand, wheat yield increases compared to previous years due to factors such as the development of technology, the expansion in irrigation areas, and the use of certified seeds. Wheat imports also have been increased due to population growth, increases in livestock, internal processing, and the development of the flour and flour products industry in Turkey. It is expected that wheat imports will continue. To prevent this situation, wheat cultivation areas should be expanded and producers should be supported more with public policies that increase production. For this, it is necessary to increase the efficiency of agricultural extension activities, to ensure the participation of farmers, and to apply competitive support policies to strategic products such as wheat.



Copyright ©2016 by authors and Galileo Institute of Technology and Education of the Amazon (ITEGAM). This work is licensed under the Creative Commons Attribution International License (CC BY 4.0).

### I. INTRODUCTION

Due to the climate change and droughts that have become more common globally in recent years, the issue of food safety has started to raise concerns and more frequently [1–3]. Of the approximately 1.5 billion hectares of agricultural land in the world, 718 million hectares of grain are cultivated and around 2.9 billion tons of production is made [4], [5]. Wheat is a one-year field crop that can be grown all over the world and is included in the cereals group. Anatolia, Caucasus, and western Iran are known as the first production place of wheat in the records [6–8]. Wheat is the raw material of bread, which is the main food source for humans and is used as feed in livestock and poultry. Grain and cereal products are

important foods for health because they contain vitamins, minerals, carbohydrates (starch, pulp), and other nutrients and have high carbohydrate content. Therefore, grains are among the main energy sources of the body [7], [9], [10]. While corn ranks first in grain production in the world, wheat is located the first in Turkey [11]. Wheat was a crop that was mostly produced under dry farming conditions until recently, but today, with the developing technology and irrigation, significant productivity increases have been achieved in the production amount. This situation started to make wheat a more competitive product compared to other annual crops. On the other hand, although wheat is grown in every region in Turkey, the Central Anatolia region is produced the most where the continental climate is dominant [12].

In the consumption of wheat as food, it can be ground or peeled in various machines and offered for sale according to the purpose of use. It is also produced as well as feed for farm animals in Turkey. The straw remaining after the wheat harvest is used as cattle and ovine feed-in farms. Livestock enterprises are mostly composed of small and scattered family businesses and the production of feed crops in these enterprises is not adequate [13]. The increase in input prices, while causing a decrease in the production of fodder crops, this situation also hampers the development of animal production potential in Turkey at the desired level [14]. Another reason that makes the wheat production important in Turkey is that forage crops as the first or second product has the limited cultivation of agricultural land [15]. Barley and wheat are mostly used as fodder crops in small family businesses in animal husbandry. In this sense, wheat production also affects animal husbandry. Because grains used as feed are important for livestock businesses [16].

Turkey has become an important exporter in the world with exports of finished products based on wheat. As Turkey's most bakery products, pasta, boiled and pounded wheat, grits and biscuits are made for export. The highest increase in finished product exports was in pasta in 2018 [11]. On the other hand, wheat straw can be processed industrially and used in paper production. The multi-purpose usage of the wheat situation reveals the importance of wheat in Turkey. Since wheat has always been an important foodstuff for living things, it has been supported to be produced as a strategic product. Public support policies implemented varied according to years and conditions [17]. Therefore, wheat cultivation in Turkey is supported as a public policy. Within the scope of agricultural support payments to farmers for wheat are as follows: 190 Turkish Lira (TL)/hectare (ha) of diesel support, 80 TL/ha fertilizer support, 0.05 TL/kg difference payment support, 85 TL/ha certified seed usage support and 0,10 TL/kg certified seed production support is provided in 2020 in Turkey. 1 USD average equal to 6.96 Turkish Lira [18]. Besides, it was decided to pay 40 TL for 5 ha and above land and 10 TL for solid organic-organomineral fertilizer support. When barley and wheat are produced as green grass as forage crops, it is given as 300 TL/ha per year within the support program [19]. The implementation of public agricultural support cannot be said that it satisfies farmers sufficiently in Turkey [20].

Because wheat is the main nutrient, it is produced by all countries. According to the 2020 data of the Food and Agriculture Organization (FAO), the first 20 countries in terms of wheat cultivation areas in the world are given in Figure 1.

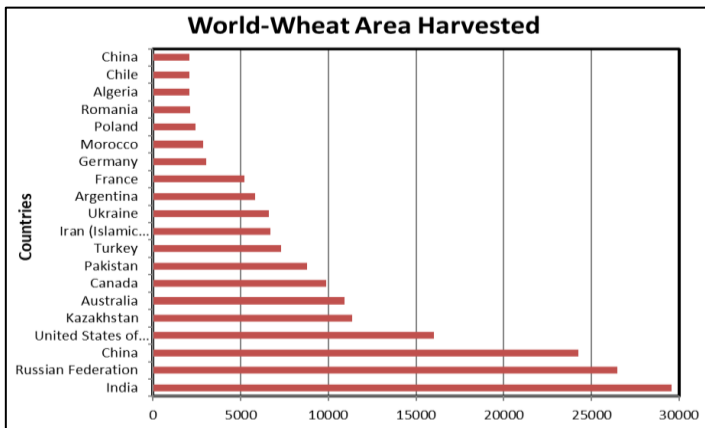

Figure 1: Cultivation areas of top 20 wheat producing countries in 2018. Source: [21].

The amount of wheat production in Turkey is mostly determined by the nature and place of production conditions. Therefore, wheat production varies from year to year and depending on the climate. According to data from the FAO Global wheat cultivation area for Turkey, it ranks 9th in 2018. Last 14 years (2005-2018) wheat production areas in the world increased by 6.70%, while wheat production area in Turkey has decreased by 20.98%. This ratio was 21.09% when it is calculated according to the data of the Turkey Statistical Institute (TUIK) [12], [21]. While the wheat cultivation area increases in the world, the acreage is declining in Turkey. Although Anatolia is among the known homelands of wheat, the expansion of irrigated areas and areas for various economic reasons wheat production is declining in Turkey. The first 20 countries in terms of wheat production amount in the world are given in Figure 2.

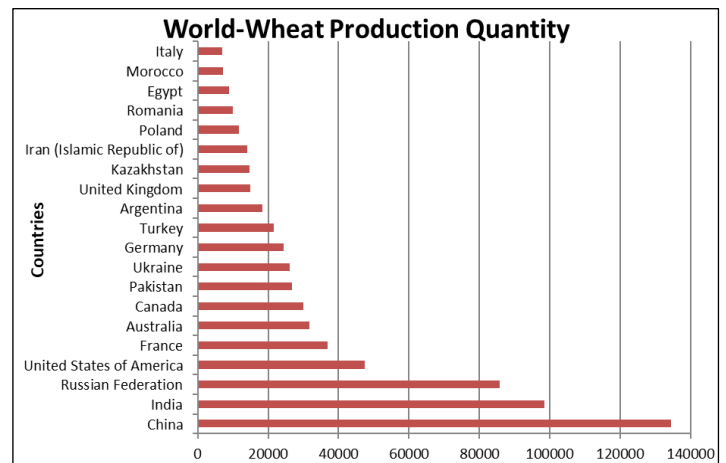

Figure 2: The production amount of top 20 wheat producing countries in 2018. Source: [21].

The average production value of the first 20 countries has been calculated as 33 514 thousand tons' for the year 2018 in Figure 2. Turkey's wheat production quantity was 21 500 thousand tons in the year 2018, which was 64.15% of the average of the top 20 countries in the world. Turkey ranks 11th in world wheat production by this amount [4]. Although wheat production in Turkey with favorable climatic conditions, its production decreases due to decrease of agricultural cultivation areas, preferring other products with high economic value instead of cultivating wheat, increase in input costs, insufficient incentives given, and not being able to combat pests sufficiently. As in all the world, as well as increases in food prices together with increasing demand being experienced in Turkey. This situation makes it obligatory for every country to produce at least enough wheat for its domestic consumption.

The purpose of this study is to evaluate the wheat market situation and evaluation of implemented policies in recent years in the world and Turkey. For this purpose, wheat production, consumption, yield, average selling price, export-import value, the foreign trade balance was investigated for Turkey. Depending on the available data, projections were made until 2024.

## II. MATERIALS AND METHODS

In this study, data from TUIK and FAO, related sector reports, and other studies were used. Secondary data were used in this research. For this purpose, data between 2005 and 2019 were used to analyzes wheat production area, production amount (tons),

yield per acreage (kg), sales price (kg/TL), foreign trade balance, import, and export. As a method in the study, trend analysis was made in the Microsoft Office program with the data obtained from TUIK and FAO data. In these analyzes, projections were made until 2024, using data from 2005 and 2019. Also, other studies and researches on the subject have been used to interpret the results.

### III. RESULTS AND DISCUSSIONS

To determine the change in Turkey by years of wheat acreage and projections to predict the future using the TUIK data for the years 2005-2019, and trend analysis has been conducted until 2024 and is shown in Figure 3.

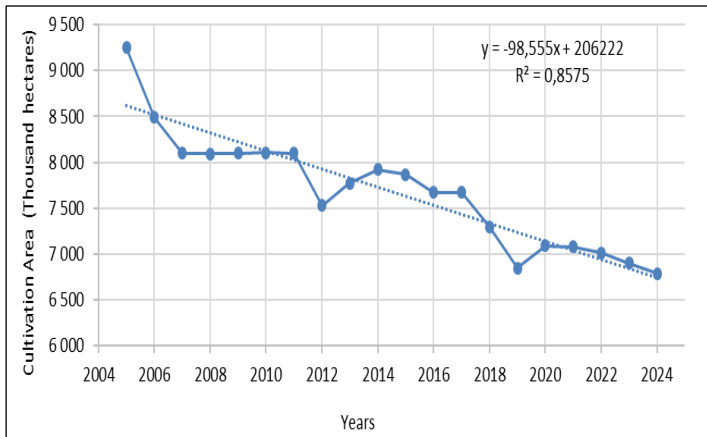

Figure 3: Wheat cultivation areas between the 2005-2024 year in Turkey. Source: [12].

Accordingly, the wheat cultivation areas in Turkey is decreased at a rate of 12.46% between 2007 and 2005. Between the years of 2007-2011, wheat cultivation areas are generally at the same level and no significant change was observed. There was a 7.00% decrease in the cultivation area in 2012. While an increasing trend was observed in wheat cultivation areas between 2012 and 2014, it has a decreasing slope after 2014. Wheat cultivation area has reached its lowest level in 2019 in Turkey. While there is a slight increase tendency in the trend analysis to 2021, it has a decreasing slope from 2021 until the end of the analysis period [12]. The fluctuations in the wheat cultivation areas between the dates discussed also manifested themselves in the presence of animal numbers. Analysis of projections up to the year 2024 is expected to continue the downward trend in wheat-growing areas in Turkey. The regression coefficient in the projection analysis up to 2024 is 0.86. If additional measures are not taken, it is interpreted that the decrease in the cultivation areas will continue in the future.

Data for the years 2005-2019 were used to determine the changes over the years and the average selling price of wheat in Turkey and also to estimate future periods projection. Trend analysis has been made on these data until 2024 and is given in Figure 4.

The regression coefficient of the trend analysis performed is 0.96 and shows an increasing trend. This situation is interpreted as that wheat prices will increase in the future. In general wheat sales prices between 2005 and 2019 have shown a rising slope in Turkey. This increase in prices is explained by a decrease of 11.63% in wheat production between the aforementioned periods. As prices depend on supply and demand under general economic conditions, and it is an expected situation that prices will increase as the amount of supply decreases [22].

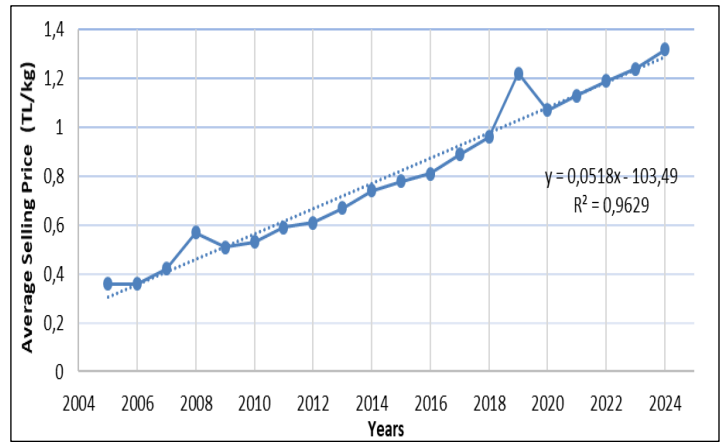

Figure 4: The average sales price of wheat in Turkey between the years 2005 to 2024. Source: [22].

At the beginning and the end of the research period, an increase of 237.5% in average wheat sales prices was determined. The average selling price in Turkey has not been a significant price change in 2006 compared to the previous year. An increase of 18.30% was determined in the average wheat sales price in 2007. An increase of 35.71% was determined compared to the previous year in 2008. On the other hand, there was a 10.53% decrease in 2009 compared to the previous year. The wheat average sales price is increased by 81.13% between 2010 and 2018. An increase of 26.56% compared to the previous year was observed, and the price reached a peak with 0.96 TL/kg in 2019. According to the projections, a decrease of 14.02% is expected in 2020 compared to the previous year, while it is predicted that the average sales price will increase by 16.81% between 2021-2024 [22].

Depending on the year's wheat acreage decreased in Turkey, while increasing productivity. This situation arises due to the areas with irrigation and developing technologies in agricultural production. The data of 2005 and 2019 were used to determine the amount of change in wheat yield by year's and to estimate future projections in Turkey. Then, with these data, the yield (kg/ha) variation graph of wheat was obtained until 2024 and is shown in Figure 5.

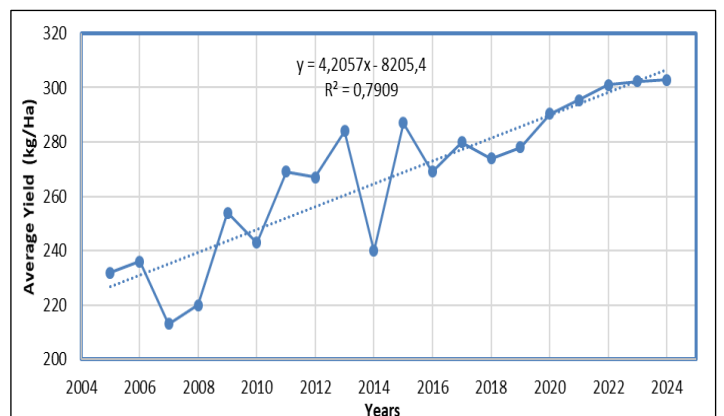

Figure 5: The average yield of wheat in Turkey between the years 2005 to 2024. Source: [12], [23].

The yield, which was 2 324 kg/ha in 2005, increased and decreased at a fluctuating rate in the analyzed period, and reached 2 772 kg/ha in 2019. According to the data, while the yield increased by an average of 19.40% between 2005 and 2019, the

cultivation areas decreased by 25.99%. The fluctuating change in yield is explained by climatic conditions and precipitation. Because wheat production in Turkey is mostly done in dry farming conditions. It was determined that the efficiency was in an increasing trend and the regression coefficient was 0.79 in the projections made between 2005 and 2024 [12], [23]. There are many factors affecting yield in agricultural production. Soil and cultivation, agricultural struggle, fertilization, irrigation, seed improvement, mechanization, foundations that support agriculture, and easily marketable product are among the factors affecting yield [24–26]. Agricultural technologies, high-quality seeds, and inputs are predicted to be effective in this yield increase.

Wheat yield was found to be the lowest in 2007 during the research period, and the reason for this is that the precipitation in this year decreased by 8.6% compared to normal periods [27]. During the research period, the yield fluctuated continuously between 2008 and 2013 depending on the changing climate conditions, and this period's average yield increased by 29.07%. On the other hand, the average yield decreased in 2014, and the largest increase in productivity was experienced in 2015. This situation can be explained by the spatial distribution of precipitation [28]. Average yield decreased in 2016 due to the distribution of precipitation globally. Turkey has received an average of 597.6 mm rainfall in 2016 [29]. Although the total amount of precipitation in 2017 was 506.6 mm, which was 12% below the 574 mm which was the average of 1981-2010 [30], the yield was increased. On the other hand, the average rainfall was 658.7 mm in 2018 which was above the long-term average of 14.8% and it was 30.0% more than the precipitation in 2017 in Turkey [31]. However, unlike the increase in precipitation in 2018, wheat yield decreased by 2.27% compared to the previous year. These results are interpreted as the occurrence of rainfall based on spatial distribution except the total amount of precipitation and other factors rather than climates, such as irrigation, fertilizer, and seeds. Especially in this year, fertilizer prices in Turkey, depending on the depreciation of TL, due to increased imports. These extraordinary price increases have caused some of the farmers to give up production, or to reduce their land and the amount of fertilizer they use in production [32]. There was an increase of 1.29% in 2019. Based on the data obtained by the projections made between the years 2020-2024 in the researched period it is estimated to be an increase in the average yield on Turkey [23].

Data for the years 2005 and 2019 were used to identify the change in the situation of wheat imports by years and to estimate future period projections in Turkey. Based on these data, trend analysis has been conducted until 2024 and is given in Figure 6.

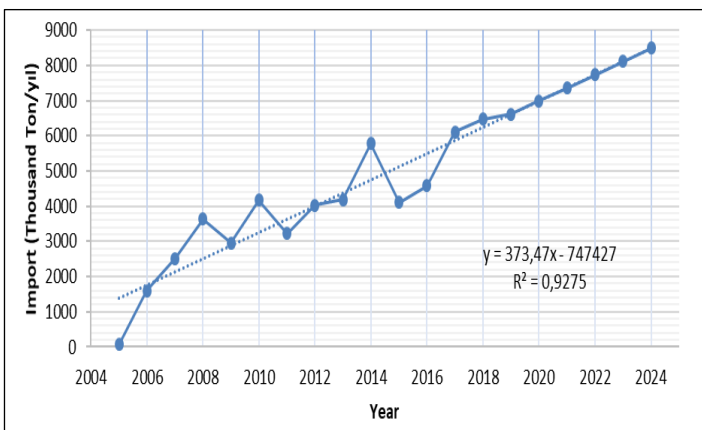

Figure 6: Wheat Import of Turkey between the years 2005-2020. Source: [23].

Although Turkey has a variable structure in terms of foreign trade was mostly wheat importer. Turkey's wheat imports, including the export processing, production areas, and quantities, vary according to years, depending on the use of domestic raw materials as food and feed. However, considering the data from the research period, the increase and decrease in the amount of imports are mostly explained by processed internally and then exports, cultivation areas, yield, and climate-based precipitation. The increase in the import rate was directly proportional to the increasing demand and the number of animals. In the researched period, the cultivation areas decreased by 25.99%, and they have a decreasing slope in the future [23].

In some production periods, because wheat processing facilities operate below the current capacity, during the dry season, wheat production was at a level that cannot meet domestic consumption, therefore wheat import becomes obligatory [17]. According to the trend analysis, the regression coefficient was 0.93, and wheat import is expected to be in an increasing slope until 2024. According to the current data, these increases stem from the increase in consumption, the decrease in the cultivation areas, the export made by internal processing, and the use of feed-in livestock breeding.

The import and export of data of 2005 and 2019 years were used for the determination of the change in the trade balance over the years and future projections estimate in Turkey. For this purpose, trend analysis has been made until 2024, and it is given in Figure 7.

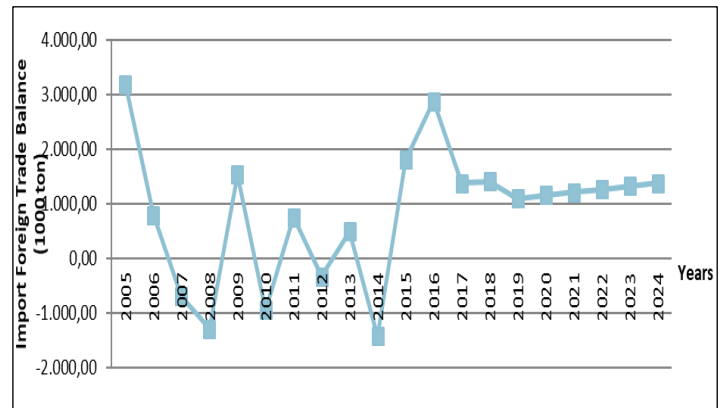

Figure 7: Wheat trade balance of Turkey Between the years 2005-2024.

Source: [23].

Turkey within the researched period, the trade balance has shown a fluctuating structure, generally has been an importer. The essence of these fluctuations is the imbalances in the production amount due to climate conditions, and the increase and decrease in the cultivation areas due to the farmers preferring other products with high economic value supported by the state instead of wheat. In the projections made for the years between 2020 and 2024, it is predicted that the foreign trade balance deficit will increase by 19.23% [23].

#### IV. CONCLUSIONS

Although Turkey to take place within the first 10 countries in the world wheat acreage, wheat production amount is lower than the rate it. The cultivated wheat variety, climatic conditions, and dry farming are some of the main reasons why the wheat yield is below the world average. Concerning the trend analysis, wheat acreage decreases with each passing day and average sales prices



are increasing in Turkey. On the other hand, it has been determined that wheat yield has increased compared to previous years due to factors such as the development of technology, increase in irrigation areas, and the use of certified seeds. In Turkey, population growth, the increase in the feed and livestock, flour and flour products in wheat imports have increased steadily with the development of the industry next year and is expected to continue this growth. Due to demand based on population growth, the increase in the feed and livestock, flour and flour products with the development of the industry has shown a continuous increase in wheat imports, and this increase is expected to continue in imports for the coming years in Turkey. To prevent this situation, wheat cultivation areas should be expanded and producers should be supported more with public policies that increase production. This includes increasing the efficiency of agricultural extension activities, ensuring the participation of farmers [33], and applying competitive support policies to strategic products such as wheat.

## V. AUTHOR'S CONTRIBUTION

**Conceptualization:** Mehmet Cançelik, Zeliha Şahin and Mustafa Hakkı Aydoğdu.

**Methodology:** Mehmet Cançelik, Mehmet Reşit Sevinç, Nihat Küçük and Mustafa Hakkı Aydoğdu.

**Investigation:** Mehmet Cançelik, Zeliha Şahin and Nihat Küçük.

**Discussion of results:** Mehmet Cançelik and Mehmet Reşit Sevinç.

**Writing – Original Draft:** Mehmet Cançelik, Mehmet Reşit Sevinç and Mustafa Hakkı Aydoğdu.

**Writing – Review and Editing:** Mehmet Cançelik, Mehmet Reşit Sevinç and Mustafa Hakkı Aydoğdu.

**Resources:** Mehmet Reşit Sevinç, Zeliha Şahin and Nihat Küçük.

**Supervision:** Mehmet Cançelik.

**Approval of the final text:** Mehmet Cançelik, Zeliha Şahin, Mehmet Reşit Sevinç, Nihat Küçük and Mustafa Hakkı Aydoğdu.

## VI. REFERENCES

- [1] M.H. Aydoğdu, "Farmers' risk perception and willingness to pay for environment: Case study of GAP-Sanlıurfa, Turkey," *Fresenius Environmental Bulletin*, vol. 25, no. 12, pp. 5449–5455, 2016.
- [2] M. H. Aydoğdu, "Farmers' attitudes to the pricing of natural resources for sustainability: GAP-Şanlıurfa sampling of Turkey," *Water*, vol. 11, no. 9, Art. no. 9, Sep. 2019, doi: 10.3390/w11091772.
- [3] M. H. Aydoğdu and K. Yenigün, "Farmers' risk perception towards climate change: A case of the GAP-Şanlıurfa region, Turkey," *Sustainability*, vol. 8, no. 8, Art. no. 8, 2016, doi: 10.3390/su8080806.
- [4] Food and Agriculture Organization (FAO), "Statistical Databases," 2016. <http://www.fao.org/faostat/en/#data/QC> (accessed Jan. 04, 2018).
- [5] Ö. D. E. Köse and Z. Mut, "Tahıl ve tahıl ürünlerinin insan beslenmesi ve sağlık açısından önemi, Yozgat'ta tahılların durumu," in *Bölgesel Kalkınma ve Sosyo-Kültürel Yapı, Yozgat*, May 2018, vol. 1, pp. 1121–1130.
- [6] B. Atar, "Gıdamız buğdayın, geçmişten geleceğe yolculuğu," *Yalvaç Akademi Dergisi*, vol. 2, no. 1, Art. no. 1, Dec. 2017.
- [7] F. Özberk, A. Karagöz, İ. Özberk, and A. Atli, "Buğday genetik kaynaklarından yerel ve kültür çeşitlerine; Türkiye'de buğday ve ekmek," *Tarla Bitkileri Merkez Araştırma Enstitüsü Dergisi*, vol. 25, no. 2, Art. no. 2, Dec. 2016.
- [8] A. T. Özcan, "Altın Orda Hanlığı zamanında Karadeniz'in Kafkasya sahillerinde Cenovalı tüccarlar, kolonileri ve ticari yaşam," *Marmara Türkiyat Araştırmaları Dergisi*, vol. 7, no. 1, Art. no. 1, Jun. 2020, doi: 10.16985/mtad.752865.
- [9] G. Kotancılar, İ. Çelik, and Z. Ertugay, "Ekmeğin besin değeri ve beslenmedeki önemi," *Atatürk Üni.Zir.Fak.Der.*, vol. 26, no. 3, pp. 431–441, 1995.

- [10] A. Keçeli, "A review on the bioactive, antioxidant properties of einkorn (triticum monococcum l. ssp. monococcum) populations and using in organic agriculture," *Turkish Journal of Agriculture - Food Science and Technology*, vol. 7, no. 12, Art. no. 12, Dec. 2019, doi: 10.24925/turjaf.v7i12.2111-2120.2833.
- [11] Toprak Mahsulleri Ofisi Genel Müdürlüğü (TMO), "2018 Hububat Sektör Raporu," Mar. 2019. <https://www.tmo.gov.tr/Upload/Document/hububatsektorraporu2018.pdf> (accessed Dec. 17, 2020).
- [12] TUIK, "Crop production statistics," 2020. <https://biruni.tuik.gov.tr/medas/?kn=92&locale=tr> (accessed Jul. 09, 2020).
- [13] M. H. Aydoğdu, İ. Aydoğdu, C. A. Cevheri, M. R. Sevinç, and N. Küçük, "Şanlıurfa'daki yem bitkileri eken çiftçilerin sosyo-ekonomik profilinin analizi," *Journal of Ekonomi*, pp. 10–15, Mar. 2020.
- [14] M. H. Aydoğdu, İ. Aydoğdu, and C. A. Cevheri, "Analysis of factors affecting the production of forage crops of farmers: GAP-Şanlıurfa Sampling of Turkey," in *Academic Studies in Economics and Administrative Sciences*, 1st ed., H. Babacan and Y. A. Unvan, Eds. Cetinje-Montenegro: Ivpe Cetinje, 2020, pp. 142–154.
- [15] M. H. Aydoğdu and N. Küçük, "General analysis of recent changes in red meat consumption in Turkey," *IOSR Journal of Economics and Finance (IOSR-JEF)*, vol. 9, no. 6–IV, pp. 1–8, 2018, doi: 10.9790/5933-0906040108.
- [16] M. H. Aydogdu and Z. Sahin, "General analysis of the recent changes of barley productions and consumptions in Turkey," *IOSR Journal of Agriculture and Veterinary Science (IOSR-JAVS)*, vol. 13, no. 1, pp. 14–19, 2020.
- [17] S. Duru, A. Gül, and S. Hayran, "Türkiye'de buğday ve buğday mamulleri dış ticaret yapısı," *Bilecik Şeyh Edebali Üniversitesi Sosyal Bilimler Dergisi*, vol. 4, no. 2, Art. no. 2, Dec. 2019, doi: 10.33905/bseusbed.563347.
- [18] Anonymous, "2020 USD - Dollar exchange rates archive," 2020. <https://paracevirici.com/doviz-arsiv/merkez-bankasi/gecmis-tarihli-doviz/2020/amerikan-dolari> (accessed Dec. 17, 2020).
- [19] Republic of Turkey Ministry of Agriculture and Forestry, "Domestic Certified Seed Use Support," 2020. <https://www.tarimorman.gov.tr/Konular/Tarimsal-Destekler/Diger-Tarimsal-Amacli-Destekler/Yurtici-Sertificali-Tohum-Kullanim-Destegi> (accessed Dec. 17, 2020).
- [20] G. Sevinç, M. H. Aydoğdu, M. Cançelik, and M. R. Sevinç, "Farmers' attitudes toward public support policy for sustainable agriculture in GAP-Şanlıurfa, Turkey," *Sustainability*, vol. 11, no. 23, Art. no. 23, Jan. 2019, doi: 10.3390/su11236617.
- [21] Food and Agriculture Organization (FAO), "Wheat production quantity and area harvested," 2020. <http://www.fao.org/faostat/en/#data/QC> (accessed Nov. 15, 2020).
- [22] TUIK, "Agricultural price statistics," 2020. <https://biruni.tuik.gov.tr/medas/?kn=110&locale=tr> (accessed Jul. 06, 2020).
- [23] TUIK, "Agricultural product balance tables," 2020. <https://biruni.tuik.gov.tr/medas/?kn=104&locale=tr> (accessed Jul. 06, 2020).
- [24] Z. Bayramoğlu, "Tarımsal verimlilik ve önemi," *Selcuk Journal of Agriculture and Food Sciences*, vol. 24, no. 3, Art. no. 3, Aug. 2010.
- [25] H. P. Doğan, M. H. Aydoğdu, M. R. Sevinç, and M. Cançelik, "Farmers' willingness to pay for services to ensure sustainable agricultural income in the GAP-Harran Plain, Şanlıurfa, Turkey," *Agriculture*, vol. 10, no. 5, Art. no. 5, May 2020, doi: 10.3390/agriculture10050152.
- [26] S. Cengiz and C. M. Baydur, "Kırdan kente göç ve tarımsal verimlilik: Türkiye örneği," *Ç.Ü. Sosyal Bilimler Enstitüsü Dergisi*, vol. 19, no. 2, pp. 85–98, Oct. 2010.
- [27] Republic of Turkey General Directorate of State Meteorological Service, "2008 climate assessment report," 2009. <https://www.mgm.gov.tr/files/iklim/2008-yili-iklim-degerlendirmesi.pdf> (accessed Nov. 15, 2020).
- [28] Republic of Turkey General Directorate of State Meteorological Service, "Climate assessment for 2015," 2016. <https://mgm.gov.tr/FILES/iklim/yillikiklim/2015-iklim-raporu.pdf> (accessed Nov. 15, 2020).
- [29] Republic of Turkey General Directorate of State Meteorological Service, "Climate Assessment for 2016," 2017.

<https://mgm.gov.tr/FILES/iklim/yillikiklim/2016-iklim-raporu.pdf> (accessed Jul. 15, 2020).

[30] Republic of Turkey General Directorate of State Meteorological Service, "Climate assessment for 2017," 2018. <https://mgm.gov.tr/FILES/iklim/yillikiklim/2017-iklim-raporu.pdf> (accessed Jul. 15, 2020).

[31] Republic of Turkey General Directorate of State Meteorological Service, "Climate assessment for 2019," 2020. <https://mgm.gov.tr/FILES/iklim/yillikiklim/2019-iklim-raporu.pdf> (accessed Jul. 15, 2020).

[32] Tarsus Commodity Exchange, "2019 Wheat condition assessment report," 2020. <http://tarsusticaretborsasi.com/DOSYALAR/pdf/2019%20BUGDAY%20RAPOR.pdf> (accessed Jul. 30, 2020).

[33] M. H. Aydoğdu, "Evaluation of farmers' willingness to pay for agricultural extension services in GAP-Harran plain, Turkey," *Journal of Agricultural Science and Technology*, vol. 19, no. 5, pp. 785–796, 2017.



ISSN ONLINE: 2447-0228



### RESEARCH ARTICLE

### OPEN ACCESS

## OPEN-SOURCE SOFTWARE IN EMERGING TECHNOLOGIES FOR ECONOMIC GROWTH

Eseosa Ehioghae\*<sup>1</sup> and Sunday Idowu<sup>2</sup>

<sup>1,2</sup> Department of Software Engineering, School of Computing and Engineering Sciences, Babcock University. Ilishan-Remo, Ogun State, Nigeria.

<sup>1</sup> <http://orcid.org/0000-0003-4890-5303> , <sup>2</sup> <http://orcid.org/0000-0002-0013-0265> 

Email: \*ehioghaes@babcock.edu.ng, idowus@babcock.edu.ng

### ARTICLE INFO

#### Article History

Received: December 10<sup>th</sup>, 2020

Accepted: January 28<sup>th</sup>, 2021

Published: February 15<sup>th</sup>, 2021

#### Keywords:

Open-Source,  
Emerging Technology,  
Economic Growth,  
Disruption,  
Creative Destruction.

### ABSTRACT

The growth of the economy is one of the aims of every country, as it ensures an improved standard of living for the citizens of such countries. One of the ways this economic growth can be achieved is by investing in technologies that can yield more efficiency in operations while reducing overall costs. The developed nations have more economic prowess because of their heavy investment in technological development, which sometimes could be elusive in developing nations. Open-source software, however, levels the playing ground as it presents strengths that can drive innovation faster than can be achieved with the proprietary software development paradigm. Emerging technologies on the other hand present transformative powers that can catalyze the economic growth of the countries that can efficiently apply them. This paper examines the key characteristics of open-source software alongside emerging technologies to establish the impact of open-source software on emerging technologies and its wider impact on economic growth. Specific emerging technologies where open-source concepts are being applied were examined to reveal the positive impact of open-source software, while at the same time, specific emerging technologies that are creating disruptions that drive economic growth were investigated. It was finally concluded that open-source software presents key strengths, which when combined with the disruptive powers of emerging technologies, presents tremendous potential to increase the economic growth of the country in which it is implemented.



Copyright ©2016 by authors and Galileo Institute of Technology and Education of the Amazon (ITEGAM). This work is licensed under the Creative Commons Attribution International License (CC BY 4.0).

### I. INTRODUCTION

Open-Source Software (OSS) is premised on the idea of open innovation, where collaboration, knowledge exchange, and volunteer software development foster innovation in the production of software applications. OSS specifically presents the idea that open software is more effective than propriety software given that OSS provides excellent opportunities for pertinent collaboration and knowledge sharing, which results in a net positive effect of allowing software to be produced by leveraging the knowledge and expertise of a wider open community more effectively, in contrast to the proprietary software development approaches which takes a more closed approach.

Emerging technologies have been a crucial area of research interest, both in academia and industry. Albeit not having a specific

definition as to which technology is emergent, various researchers have come up with definitions that attempt to describe what emerging technologies are [1-3]. Rotolo, Hicks, and Martin [1] were able to identify five key characteristics that classify a technology as emergent. They include (i) radical novelty, (ii) relatively fast growth, (iii) coherence, (iv) prominent impact, and (v) uncertainty and ambiguity. Furthermore, they gave a more specific definition of emerging technology as “a radically novel and relatively fast growing technology characterized by a certain degree of coherence persisting over time and with the potential to exert a considerable impact on the socio-economic domain(s) which is observed in terms of the composition of actors, institutions and patterns of interactions among those, along with the associated knowledge production processes. Its most prominent impact, however, lies in the future and so in the emergence phase is still

somewhat uncertain and ambiguous” [1]. One can readily identify disruptive technologies such as Artificial Intelligence, the Internet of Things (IoT), Blockchain, Autonomous Devices as examples of technologies that can fall within the categories of technologies called emerging technology.

The intrinsic nature of knowledge sharing and collaboration present in OSS can greatly contribute to emerging technologies. Novel ideas could be birthed from the openness of OSS, which could also yield a relatively fast growth of the technology, which in contrast could never be achieved within the closed walls of proprietary software paradigms.

The economic growth of every nation on the other hand is a key factor in measuring the success of such a nation. The United States, for example, is the world’s leading nation because of the high level of economic growth present in the country. Knowledge and collaboration play a huge role in the growth of any economy. Ghafele and Gibert [4] identified knowledge and the correct utilization of technology as a crucial indicator of national growth. Hence, the right application of technology with knowledge sharing and collaboration presents an appropriate climate for innovation, which fortunately are the tenets on which OSS rests on.

This research, therefore, identifies the positive impacts of OSS within emerging technologies, which can catalyze the economic growth of any nation in which OSS paradigms are adopted.

## **II. OPEN-SOURCE SOFTWARE LANDSCAPE**

As has now been established, OSS presents certain characteristics which can act as a catalyst for innovation. However, crucial to understanding the impacts of OSS in the economic development of any nation is the understanding of what exactly OSS entails.

### **II.1 WHAT IS OPEN-SOURCE SOFTWARE**

OSS is another name for a broader classification of software which is called Free and Open-Source Software (FOSS). These are software that can be freely used, modified, and distributed with respect to the copyright and license of its open-source status [5, 6]. This implies that Open-Source Software generally have some licenses that dictate how the code should be freely used and distributed. For example, some open-source license mandates that the user altering and redistributing the software must also share the source code of the software and at no cost [7].

OSS today is a major pillar for innovation and ideas that birth new products faster than the in the closed walls of proprietary software development. Ebert [8] identified software technologies and processes as the most prominent areas in which open source innovations are taking place.

Software technologies have seen massive improvements and innovations since the adoption of OSS. The positive impacts of software technologies such as Apache, Linux, MySQL cannot be overemphasized as the momentum in innovation provided by these technologies is self-evident in our everyday interaction with software products. This momentum in software technologies is as a result of OSS leveraging a vast pool of developer expertise, alongside collaboration with the community, to ensure that software products produced are highly efficient, more secure, and with lesser bugs. Eric Raymond captured this more accurately when he said “given enough eyeballs, all bugs are shallow” [9].

In addition, software processes, which lead to the production and maintenance of software products, have been greatly improved due to the existence of OSS. Agile development

techniques, distributed change management, and global collaboration are just a few of the processes that have revolutionized software development. This, as Ebert [8] intuited, has been because software developers incorporated these processes in their open-source projects, which, over time, saw positive impacts in the development process, after which gained massive adoption within the global software community.

## **III. EMERGING TECHNOLOGIES LANDSCAPE**

As previously established, emerging technologies are a little difficult to readily define [1-3]. Avila-Robinson and Miyazaki [10] further clarified this by referring to the fact that attempting to give a single definition of emerging technologies has led to numerous terminologies, with overlapping concepts, which still points to the intrinsic difficulty in defining emerging technologies. Halaweh [2] also alluded to this difficulty by saying that some technologies might be considered emerging in some contexts while in some other contexts considered as established. A good example given by Halaweh [2] was Radio Frequency Identification (RFID), which is not considered as emerging in developed countries, given its widespread use, but considered emerging in many developing countries, given its low diffusion in such countries as a result of the lack of the underlying infrastructure to support it. Furthermore, Day and Schoemaker [3] defined emerging technologies as “science-based innovations that have the potential to create a new industry or transform an existing one” [3]. Adner and Levinthal [11] further hinted at this when they divided emerging technologies pattern into two broad categories of lineage development which involves a technology adapting to the particular needs of the niche it is being applied to, and creative destruction, which involves a new technology emerging from an existing one by destroying the techniques of the existing one, paving way for more efficient techniques.

As already established, the nature of emerging technologies is quite hard to qualify, as technologies considered as emerging technologies in developing countries might have plateaued in developed countries, due to their widespread implementation in the developed countries. Atkinson [12] identified a new wave of technological emergence that, although currently implemented in some industry verticals, still lack a global adoption, due to their nascent nature and the current costs involved in implementing them on a large scale. Some of these technologies include Artificial Intelligence, The Internet of Things, Blockchain, Autonomous Devices, Robotics. These are good examples of the technologies that fall under the emerging technologies umbrella based on the categorization given by Rotolo, Hicks, and Martin [1].

It should be noted that a high rate of innovation can be achieved by the strengths of OSS and emerging technologies [13] which can lead to an increase in the standard of living, and the overall economic development of countries by providing numerous job opportunities [12]. We now explore how OSS and emerging technologies lead to economic growth.

## **IV. OPEN SOURCE SOFTWARE AND EMERGING TECHNOLOGIES AS A FORCE FOR DISRUPTION AND ECONOMIC GROWTH**

OSS and emerging technologies are a great force for disruption and economic growth. Various studies have been conducted to show the net positive effects of OSS and emerging technologies in economic growth. In a study by Ghafele and Gibert [4] examining the impact of Open-Source Software on employment in the USA, it was discovered that the open innovation intrinsic to



OSS yielded employment growth with a positive impact in high-income jobs across various economic sectors in the United States, for a projection period of 10 years from 2008 to 2018. Garzarelli, Limam, and Thomassen [14] also intuited that OSS favors market expansion because of the openness of OSS organization of work, which generates knowledge from the community and thereby leading to a faster rate of innovation.

Furthermore, the Organisation for Economic Co-operation and Development [15] acknowledged that even though this positive effect of OSS and emerging technologies are self-evident in the overall economic growth of a nation, jobs and employment tend to shift from one section to another, typically from low-skilled jobs to high-skilled jobs. This also alludes to the earlier established “creative destruction” concept, where new technologies destroy old jobs (mostly low-skilled jobs) while creating new jobs requiring different and specialized skills. This is evident in an emerging technology like Autonomous Devices, where self-driving cars have the potential to create unemployment for taxi drivers and other logistics personnel, but at the same time, providing massive job opportunities for the programmers who develop the algorithms that run on such vehicles.

## **V. THE REAL-WORLD IMPACT OF OPEN SOURCE ON EMERGING TECHNOLOGIES**

As has now been established, OSS presents certain characteristics that make it a powerful force for rapid innovation, while emerging technologies we further recognized have the potential for transforming existing markets and creating new ones which in turn yield economic growth. Right now, we specifically identify certain key emerging technologies, where the positive impacts of OSS have been felt.

### **V.1 OPEN SOURCE IN ARTIFICIAL INTELLIGENCE AND MACHINE LEARNING**

Artificial Intelligence (AI) is a field of computer science involving the creation of computer systems that perform tasks such as learning, decision-making, reasoning, just like a human would do [16]. Machine Learning (ML) is a narrower field of AI which uses specialized algorithms to learn from large datasets, to learn, generalize, and predict. ML is one of the most heavily researched and technologically advanced branches of AI both in the industry and in academia. It also has seen lots of advancement due to the positive impact of OSS. For example, most of the current popular ML platforms supported by various IT giants are now open-source, such as Google Cloud Machine Learning Engine, TensorFlow by Google, Amazon’s ML engine for AWS, Unity ML Agents, Apache PredictionIO, Microsoft Distributed Machine Learning Toolkit. These open-source ML engines are majorly the tools driving innovations in the industry with regards to developing and deploying ML models at scale.

For example, TensorFlow provides a comprehensive slew of tools, libraries, and community resources that provides the capability to develop and deploy state-of-the-art ML models, as easily as possible [17]. Also, Amazon provides a comprehensive collection of ML services that allows any developer or data scientist to build, train, and deploy ML services as easily as possible. This same open-source ML engine is what powers the plethora of Amazon’s intelligent products such as Amazon Alexa, Amazon Prime Air, Amazon Go. Microsoft also provides its own open-source ML platform called Microsoft Distributed Machine Learning Toolkit, by using a distributed approach that allows multiple computers to solve complex ML problems in parallel to

ensure scalability and flexibility [18]. Some other prominent open-source ML engines include PyTorch which is supported by Facebook, Apache MXNet which is supported by the Apache Software Foundation

All of these ML engines and toolkits provided by various IT giants, which are also currently being used at scale, could not have been made possible without the significant contributions made by open-source paradigms.

### **V.2 OPEN SOURCE IN BLOCKCHAIN AND DISTRIBUTED LEDGER TECHNOLOGIES**

Blockchain is a decentralized electronic cryptographic ledger, where information called transactions, are distributed and synchronized across a network of computers, to enable decentralized generation, storage, and transfer of information [12]. The technology has garnered widespread research in both industry and academia, due to the interest in the key concepts, such as immutability, decentralization, on which the technology is founded upon. Some of the most commonly applied areas of blockchain include supply chain integration, financial services, digital identification and certification, and public records. OSS has also been able to greatly impact the development of Blockchain technology, as most of the prominent Blockchain platforms are open-source platforms.

For example, Ethereum, one of the most popular public Blockchain services currently available, featuring smart contract functionality, is an open-source project, which has largely received progress due to the contributions by the community. Also, Hyperledger Fabric, one of the most popular Blockchain systems mostly for enterprise-grade solutions, is a permissioned open-source project, hosted by the Linux Foundation. Some other common open-source Blockchain frameworks include the older and more common Bitcoin Blockchain and some other more highly efficient payment-based Blockchain networks like Ripple.

While Blockchain as a whole seems to be focused on payment and financial transactions, it should still be noted that it can be used as a cryptographically secure ledger to record anything of value, as it is currently being adopted in many other industry verticals. OSS is what is powering this rapid adoption and progress of Blockchain.

### **V.3 OPEN SOURCE IN THE INTERNET OF THINGS (IOT)**

The Internet of Things (IoT) extends the global network concept of the Internet where only people communicate with themselves using computers, to a platform for devices to communicate electronically with themselves and the physical world around them [12]. This means that the plethora of data abounding around can be shared between devices and further used for other purposes. IoT is an umbrella word used to denote many other technologies that power it, some of which include, cloud computing, sensor networks, ubiquitous connectivity. IoT together with AI presents powerful capabilities in terms of bringing intelligence to the myriads of data used and shared with IoT devices and sensors. IoT has also been able to gain huge adoption because of the open-source nature of the platforms supporting it.

For example, Kaa IoT is an open-source, highly flexible cloud-based, multi-purpose, IoT middleware platform used to implement complete end-to-end IoT solutions, connected applications, and smart products. Thinger.io is an open-source IoT platform, making provisions for a scalable cloud infrastructure that connects devices together. Thinger.io also gives a high degree of

control and flexibility as they provide RESTful APIs which users can use to integrate with the IoT services provided by the platform [19].

IoT concept is powerful as it is what is powering lots of 'smart initiatives', such as smart cities, smart manufacturing, smart agriculture, and it is the OSS concept that is truly powering this IoT movement.

#### **V.4 OPEN SOURCE IN MIXED REALITY, AUGMENTED REALITY, AND VIRTUAL REALITY**

Virtual Reality (VR) immerses users in a fully synthetic digital environment. Augmented reality (AR) overlays virtual objects in the real-world environment. Mixed reality (MR) combines both VR and AR by not just overlaying virtual objects, but also anchoring virtual objects to the real world. These three technologies in recent years have seen widespread interest most especially in education, military, fashion, sports, construction, media, telecommunications, films and entertainment, engineering, and healthcare applications. These technologies lack high adoption majorly as a result of the high cost of developing the software, and technical difficulties in implementing them, however, various IT giants like Facebook, Google, Microsoft, Magic Leap, HTC, Samsung are making their Software Development Kits (SDKs) open source to ease this barrier.

For example, ARToolKit is an open-source computer tracking library for the creation of strong augmented reality applications that overlay virtual imagery on the real world. Mixare (mix Augmented Reality Engine) is a free open-source augmented reality browser for Android and iOS platforms.

These technologies are immersive and crucial for certain industry verticals like healthcare and education but lack widespread adoption. Open-source software on the other hand is breaking the barriers to the adoption of these technologies by providing open-source SDKs and a community backing for these technologies.

#### **V.5 OPEN SOURCE IN AUTONOMOUS DEVICES**

Autonomous devices work with technologies such as AI and IoT to interact with their physical surroundings, which can further enable them to react based on the data gotten from their surrounding [12]. The most widely known autonomous device is the self-driving vehicle, which has the ability to navigate its surroundings partially or completely without human intervention. Although autonomous devices have received lots of interest, the adoption has also not been impressive, largely due to the high cost of developing the software, and technical difficulties in implementing them. However, open-source initiatives have facilitated more adoption of the technology.

For example, Apollo is an open-source, high-performance, flexible architecture that accelerates the development, testing, and deployment of Autonomous Vehicles. Autoware supports open-source projects enabling self-driving mobility, under the Autoware Foundation.

Open-source software projects are moving the bounds of what is possible in autonomous vehicles, and this is also encouraging a high adoption rate.

### **VI. THE REAL-WORLD IMPACT OF EMERGING TECHNOLOGIES ON ECONOMIC GROWTH**

Emerging technologies can bring about positive impacts on economic growth when adopted efficiently. Right now, we

specifically identify certain emerging technologies that have contributed significantly to the economic growth of the country in which it was applied. We also identify the future impact of some of these emerging technologies on economic growth to demonstrate its wider positive impact.

As Çalışkan [20] identified, the real reason for the huge difference in the economic growth between the developed and developing countries is on the grounds of technological differences. Developed countries can effectively apply technology to reduce costs and while increasing productivity gains. Çalışkan [20] further argued that technological advancements make it possible to obtain more output with the use of the same quantity of input in any production process, hence bringing savings in the workforce and capital thereby further increasing the real Gross Domestic Product (GDP), which is a true indicator of economic growth.

Emerging technologies have the potential to disrupt existing markets and create new markets. This as already established is what underpins Schumpeter's creative destruction concept in which the emergence of new markets and the prevalence of new technologies becomes possible due to the "creative destruction" of the existing markets, which finally brings about innovation, structural changes, and economic growth [21].

#### **VI.1 ARTIFICIAL INTELLIGENCE, MACHINE LEARNING AND THE IMPACT ON ECONOMIC GROWTH**

Pilot implementation, investment, and research into AI are on the increase now more than ever. In a Deloitte study [22] it was discovered that the number of projects relying on ML doubled from 2017 to 2018, which was predicted to double again by 2020. Furthermore, in a PwC report [23], it was revealed that AI had the real power to transform the productivity and GDP potential of the global economy. It was further predicted that by 2030, AI alone could contribute up to \$15.7 trillion to the global economy [23]. In another report by BusinessWire [24], AI was valued at \$1.36 billion in 2016 and was predicted to grow at a Compound Annual Growth Rate of 52% from 2017 to 2025.

Albeit the potential for future growth, AI is currently already making positive grounds in many industry verticals in our today's world. For example, in healthcare, ML algorithms have been developed to diagnose some illnesses better than human experts [25]. Also, Deep Learning algorithms that can predict the onset of heart failure and hence prevent it, have been developed [26]. In supply chain and trade logistics, ML has been disrupting the flow of activities, reducing errors while yielding more productivity in the entire production and logistics process. In a study by Min [27], the intrinsic complexity of the supply chain was highlighted and AI was identified as a technological fit that can lead to end-to-end visibility across the supply chain while yielding better information management and better business decision-making. Also, the concept of supply chain 4.0 is currently making waves, where AI, along with other key emerging technologies like IoT, robotics, have been proposed to bring about tremendous automation in the supply chain operations and then finally yielding significant performance [28].

All of these are indicative of the transforming power of AI and ML, which, although still regarded as an emerging technology, is already bringing about positive results in the economies that can truly harness its powers.

## **VI.2 AUTONOMOUS VEHICLES AND THE IMPACT ON ECONOMIC GROWTH**

Autonomous Vehicles (AVs) like self-driving cars rides on the gains of AI and ML, and it also has the potential to usher in a new age of economic growth. In a report by Mudge, et al. [29], it was predicted that the widespread adoption of AVs could yield significant economic benefits as about \$800 billion annual social and economic benefits could be realized by 2050, resulting from the reduction of vehicle crashes, productive time given back to commuters, and improved energy security by reducing dependence on oil which can also provide environmental benefits.

Although it should be noted that AVs will replace jobs with the automation of the rote activities involved in driving (meaning some people could lose their jobs), however, more jobs will be created requiring more specialized skills and knowledge. This also alludes to the previously established concept of creative destruction.

## **VI.3 BLOCKCHAIN TECHNOLOGY AND THE IMPACT ON ECONOMIC GROWTH**

At the basic level, blockchain technology ensures the transfer of money, assets, and information in a secure manner via the Internet, in the absence of a third-party financial authority, by leveraging on cryptography, and finally storing these transactions as append-only tamper-resistant data structures. One key area Swan [30] was able to identify where blockchain technology can greatly impact was on Digital Asset Registries.

Digital Asset Registries leverage blockchain for the recording, transferring, and verification of asset ownership, for example, homes, cars, stocks, bonds, mortgages, and insurances, in addition to the preservation of the integrity and authenticity of sensitive documents or records such as passports, visas, driver's licenses, birth and death certificates, voter registration, contracts, wills, patents, and medical records. This is made possible by the cryptographic security present in blockchain technology. A good example to illustrate this is Sweden's blockchain-powered land registry, which has been estimated to save taxpayers over \$106 million yearly by the elimination of paperwork, fraud reduction, and the speeding up of transactions [31]. Swan [30] further identified blockchain technology as the technology truly capable of achieving global financial inclusion, ensuring that every unbanked person wherever they might be in the world, has access to financial services.

More so, about 58% of respondents in a survey of experts by the World Economic Forum in 2015 estimated that 10% of the world's GDP will be registered on a blockchain by the year 2025 [32].

All of these are indicative of the transformative power of blockchain technology in ensuring economic growth.

## **VI.4 INTERNET OF THINGS AND THE IMPACT ON ECONOMIC GROWTH**

Internet of Things works together with AI and ML, cloud computing, sensor networks, ubiquitous connectivity to provide a global network of communicating devices. IoT is a technology that is currently impacting and will further greatly still impact consumers and industries due to the continuously increasing computing power and falling hardware prices.

McKinsey Global Institute [33] estimates that IoT will have a total potential economic impact of \$3.9 trillion to \$11.1 trillion per year in 2025 and they further suggest that IoT will contribute

about 11% of total world GDP in 2025. This alludes to the high potential of IoT in economic growth.

As has previously been identified, the main difference between the developed and developing nations is on the grounds of technological differences. The above-mentioned emerging technologies are just some of the technologies the developed nations are already relying upon for their incredible economic growth, even without leveraging the full potential of these technologies, as most of these technologies are still nascent.

## **VII. OPEN SOURCE SOFTWARE BUSINESS MODELS**

One nontrivial question to consider when dealing with open-source is, 'how do companies supporting open-source software make money so they do not go out of business?' This is because, as previously established, open-source software are freely used, modified, and distributed with respect to the copyright and license of its open-source status [5, 6], and hence, there must be a way for companies offering open-source software to make money. Right now, we identify some of the important business models behind some open-source projects, to show how companies behind such projects make profit out of it.

### **VII.1 SUPPORT AND SERVICES**

Since open-source software itself is not sold, the support model involves selling crucial services such as technical support, deployment and integration services, consulting, training to businesses that want to deploy the software in a production scenario. With this, customers do not pay for the software itself, rather they pay for just support of the software if they so choose to. This gives another crucial advantage as customers can choose to switch to a similar software product if the current one does not satisfy their needs, as there is no payment for the software itself but just the services offered.

Another dimension taken by companies is to sell a packaged executable of their software to only customers who are willing to pay, while still leaving the source code open source. This way, the companies implicitly offer the service of compiling and packaging their source code as an executable binary. RedHat is one of the successful companies relying on this support and service model.

### **VII.2 SOFTWARE AS A SERVICE (SAAS)**

In the SaaS model, the software is hosted on the cloud, which can be accessed from anywhere via a web browser. What makes the SaaS model work is the provision of subscriptions to more services by paying more money. What that means is that, although the base services of the software could be offered for free, the more advanced and most times useful services have to be paid for. SaaS models are flexible enough to give customers the ability to choose payment models that suits their needs. For example, a pay-as-you-go model is most common with the SaaS model subscriptions. WordPress is an example of a successful company relying on this model.

### **VII.3 DUAL-LICENSING**

In this model, the software company maintains two separate license – an open-source license where the software is free and open, and a proprietary license requiring payments. The open-source license usually provides the basic functionalities that can facilitate testing, proof of concept development, and small-scale development, thereby enabling customers to understand the



software to a reasonable extent. However, the more advanced features such as monitoring, administration, backup/restore as is in the case of database software programs, which are required for a production scenario, are reserved for a commercial license. MySQL database, a pioneer of this dual-licensing model, is an example of a software product relying on this model for profit-making.

#### VII.4 ADVERTISEMENT-BASED MODEL

This model involves the commercialization of OSS by providing advertisement opportunities in such OSS. Many big companies such as Google, Mozilla profit from this model by providing avenues for other companies and businesses to advertise on their platforms for a fee. Another concept is the one done by Adblock Plus, the popular open-source ad-blocking extension, where their profit comes from the company offering advertisers the ability to not have their ads blocked by their plugin by paying a fee for that.

#### VII.5 PAID CERTIFICATION

This model relies on the popularity of the software as if it is popular enough, certification opportunities could be offered for professionals who want to validate their skills and knowledge to advance their careers and stay relevant. Certifications provide a win-win situation as the companies offering them make more money, while the certification lends additional credibility to the professionals getting certified and most times even to the companies they work for. RedHat is also another open-source giant that relies on this model for profitmaking.

The above-mentioned business models are just some of the common models used by OSS companies to make profit from their software, as the list of business models is inexhaustive. Hence, even though OSS are freely used, modified, and distributed, tremendous profits can still be made out of it.

### VIII. CONCLUSION

In this research, the concept of OSS was largely explored, where the major tenets of OSS such as collaboration, knowledge sharing, and volunteer software development, were investigated to see how OSS fosters innovation. Furthermore, emerging technologies, which have the potential to greatly disrupt existing markets and create new markets were also considered. It was then discovered that although OSS and emerging technologies are a powerful force for disruption and economic growth, their prevalence tends to cause a shift in the market, leading to new jobs requiring specialized skills, replacing the low-skilled old jobs. This as was highlighted had the effect of causing massive unemployment to some people, while at the same time, giving jobs to some other people – those possessing the right skillset. Finally, this research investigated the current strides made in emerging technologies due to the impact of OSS, which in turn increases economic growth. This led to the conclusion that OSS techniques should be encouraged, as it can lead to the rapid development of the economy of the country in which it is implemented.

### IX. AUTHOR'S CONTRIBUTION

**Conceptualization:** Eseosa Ehioghae and Sunday Idowu.

**Methodology:** Eseosa Ehioghae and Sunday Idowu.

**Investigation:** Eseosa Ehioghae and Sunday Idowu.

**Discussion of results:** Eseosa Ehioghae and Sunday Idowu.

**Writing – Original Draft:** Eseosa Ehioghae.

**Writing – Review and Editing:** Eseosa Ehioghae and Sunday Idowu.

**Resources:** Eseosa Ehioghae and Sunday Idowu.

**Supervision:** Sunday Idowu.

**Approval of the final text:** Sunday Idowu.

### X. REFERENCES

- [1] D. Rotolo, D. Hicks and B. R.Martin, "What is an emerging technology?," Research Policy, vol. 44, no. 10, pp. 1827-1843, 2015.
- [2] M. Halaweh, "Emerging Technology: What is it?," Journal of Technology Management & Innovation, vol. 8, no. 3, pp. 108-115, 2013.
- [3] G. S. Day and P. J. H. Schoemaker, Eds., Wharton on Managing Emerging Technologies, 1st ed., Wiley, 2000.
- [4] R. Ghafele and B. Gibert, "Open Growth: The Impact of Open Source Software on Employment in the USA," International Journal of Open Source Software and Processes (IJOSSP), vol. 5, no. 1, 2014.
- [5] C. Ebert, "Open Source Software in Industry," IEEE Software, vol. 25, no. 3, pp. 52-53, 2008.
- [6] FLOSS Manuals, "Practical Open Source Software Engineering," 2020. [Online]. Available: <http://write.flossmanuals.net/practical-open-source-software-engineering/introduction-to-foss/>. [Accessed 25 October 2020].
- [7] Red Hat, "What is open source?," 2020. [Online]. Available: <https://opensource.com/resources/what-open-source>. [Accessed 25 October 2020].
- [8] C. Ebert, "Open Source Drives Innovation," IEEE Software, vol. 24, no. 3, pp. 105-109, 2007.
- [9] E. Raymond, "The cathedral and the bazaar," Knowledge, Technology & Policy, vol. 12, pp. 23-49, 1999.
- [10] A. Avila-Robinson and K. Miyazaki, "Conceptualization and Operationalization of Emerging Technologies: A Complementing Approach," in 2011 Proceedings of PICMET '11: Technology Management In The Energy-Smart World (PICMET), Portland, 2011.
- [11] R. Adner and D. A. Levinthal, "The Emergence of Emerging Technologies," California Management Review, vol. 45, no. 1, pp. 50-66, 2002.
- [12] R. D. Atkinson, "Emerging Technologies and Preparing for the Future Labor Market," Information Technology and Innovation Foundation (ITIF), 2018.
- [13] A. Nayyar, "Top Emerging Open Source Technologies," 2018. [Online]. Available: <https://www.opensourceforu.com/2018/03/top-emerging-open-source-technologies/>. [Accessed 26 October 2020].
- [14] G. Garzarelli, Y. R. Limam and B. Thomassen, "Open Source Software and Economic Growth: A Classical Division of Labor Perspective," Information Technology for Development, vol. 14, no. 2, pp. 116-135, 2008.
- [15] Organisation for Economic Co-operation and Development, "Technology, Productivity and Job Creation: Best Policy Practices," Organisation for Economic Co-operation and Development.
- [16] D. Castro and J. New, "The Promise of Artificial Intelligence," Center for Data Innovation, 2016.
- [17] TensorFlow, "TensorFlow," 2020. [Online]. Available: <https://www.tensorflow.org/>. [Accessed 30 October 2020].
- [18] G. Thomas, "Microsoft open sources Distributed Machine Learning Toolkit for more efficient big data research," 2015. [Online]. Available: <https://www.microsoft.com/en-us/research/blog/microsoft-open-sources-distributed-machine-learning-toolkit-for-more-efficient-big-data-research/>. [Accessed 30 October 2020].
- [19] thinger.io, "thinger.io," 2018. [Online]. Available: <https://thinger.io/>. [Accessed 30 October 2020].
- [20] H. K. Çalışkan, "Technological Change and Economic Growth," Procedia - Social and Behavioral Sciences, vol. 195, pp. 649-654, 2015.



- [21] M. Justman and M. Teubal, "A Structuralist Perspective on the Role of Technology in Economic Growth and Development," *World Development*, vol. 19, no. 9, pp. 1167-1183, 1991.
- [22] Deloitte, "Machine learning: things are getting intense," Deloitte, London, 2017.
- [23] PwC, "Sizing the prize What's the real value of AI for your business and how can you capitalise?," PwC, 2017.
- [24] BusinessWire, "Global Artificial Intelligence Market 2017-2025 - Growth Trends, Key Players, Competitive Strategies and Forecasts Report - Research and Markets," 2017. [Online]. Available: <https://www.businesswire.com/news/home/20171130005513/en/Global-Artificial-Intelligence-Market-2017-2025---Growth>. [Accessed 1 November 2020].
- [25] T. Kubota, "Stanford algorithm can diagnose pneumonia better than radiologists," 2017. [Online]. Available: <https://news.stanford.edu/2017/11/15/algorithm-outperforms-radiologists-diagnosing-pneumonia/>. [Accessed 1 November 2020].
- [26] E. Choi, A. Schuetz, W. F. Stewart and J. Sun, "Medical Concept Representation Learning from Electronic Health Records and its Application on Heart Failure Prediction," Cornell University, Atlanta, 2016.
- [27] H. Min, "Artificial intelligence in supply chain management: theory and applications," *International Journal of Logistics: Research and Applications*, vol. 13, no. 1, pp. 13-39, 2010.
- [28] K. Alicke, J. Rachor and A. Seyfert, "Supply Chain 4.0 – the next-generation digital supply chain," McKinsey & Company, 2016.
- [29] R. Mudge, D. Montgomery, E. Groshen, J. P. Macduffie, S. Helper and C. Carson, "America's Workforce and the Self-Driving Future: Realizing Productivity Gains and Spurring Economic Growth," *Securing America's Future Energy (SAFE)*, 2018.
- [30] M. Swan, "Anticipating the Economic Benefits of Blockchain," *Technology Innovation Management Review*, vol. 7, no. 10, pp. 6-13, 2017.
- [31] J. I. Wong, "Sweden's blockchain-powered land registry is inching towards reality," 2017. [Online]. Available: <https://qz.com/947064/sweden-is-turning-a-blockchain-powered-land-registry-into-a-reality/>. [Accessed 1 November 2020].
- [32] World Economic Forum, "Deep Shift - Technology Tipping Points and Societal Impact," World Economic Forum, 2015.
- [33] McKinsey Global Institute, "The Internet of Things: Mapping the value beyond the hype," McKinsey & Company, 2015.