



ISSN ONLINE: 2447-0228

ITEGAM-JETIA

Manaus, v.10 n.47, p. 151-158. May/June., 2024.

DOI: <https://doi.org/10.5935/jetia.v10i47.1133>

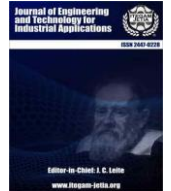

RESEARCH ARTICLE
ACCESS

OPEN

PERFORMANCE EVALUATION OF NOVEL EV CHARGING TOPOLOGY FOR STANDALONE PV SYSTEMS WITH CHARGE CONTROLLER

*Bondu Pavan Kumar Reddy¹, Vyza Usha Reddy².

^{1,2}Sri Venkateswara University College of Engineering, Sri Venkateswara University, Tirupati, INDIA

¹<http://orcid.org/0000-0001-8845-571X>, ²<http://orcid.org/0009-0004-7070-8925>,

Email: ¹pavankumar.eee216@gmail.com*, ²vyzaushareddy@yahoo.co.in.

ARTICLE INFO

Article History

Received: May 05st, 2024

Revised: June 03rd, 2024

Accepted: June 25th, 2024

Published: July 01st, 2024

Keywords:

Standalone PV System,
EV charging,
Charge Controller,
Constant current charging,
Constant voltage absorption.

ABSTRACT

This study explores the novel battery charging topology for standalone solar photovoltaic (PV) systems incorporating charge controller. The research leverages MATLAB/Simulink for modeling and simulation. In standalone PV systems, directly connecting batteries to PV modules can lead to detrimental overcharging or over-discharging, ultimately reducing battery lifespan. To mitigate this challenge, charge controllers are implemented. These intelligent devices regulate the output voltage and current from the solar panels, ensuring safe and efficient battery operation by preventing both overcharging and over-discharging. The analysis focuses on a PV-powered Single Ended Primary Inductor Converter topology alongside a modified version. These topologies integrate Perturb and Observe (P&O) and Incremental Conductance MPPT algorithms for optimal power extraction. The battery charge controller employs a three-stage strategy i.e., constant current, constant voltage absorption, and float charging to effectively manage the battery charging process. Performance evaluation considers MPPT tracking efficiency (achieving up to 98% under standard test conditions), battery charging effectiveness, and overall charge controller efficiency. The study aims to validate these results by benchmarking against a commercially available MPPT controller. The research concludes that the modified SEPIC topology with the implemented charge controller demonstrates superior suitability for EV charging applications compared to the standard SEPIC topology.



Copyright ©2024 by authors and Galileo Institute of Technology and Education of the Amazon (ITEGAM). This work is licensed under the Creative Commons Attribution International License (CC BY 4.0).

I. INTRODUCTION

In our reliance on rechargeable batteries, from smartphones to electric vehicles, a crucial but often overlooked component safeguards their health and longevity: the charge controller. This silent guardian manages the flow of electricity, preventing damage and maximizing battery life [1].

For both solar and wind energy systems, the charge controller acts as the intermediary between the power source and the battery bank. Unlike a simple on/off switch, batteries require a sophisticated charging approach. They have a specific capacity (measured in Amp-hours) and voltage tolerance. Exceeding these limits can have detrimental effects, including shortened lifespan, heat generation, and even production of harmful gases with

potential electrolyte loss. Understanding how charge controllers work unlocks the secrets to optimal battery performance and extends the life of this valuable power source [2].

The block diagram of the proposed battery charging topology for standalone solar photovoltaic (PV) systems incorporating charge controller is as shown in Figure 1. Where V_{PV} , I_{PV} , V_{Batt} , I_{Batt} , SoC denotes solar PV voltage, solar PV current, battery voltage, battery current and battery state of charge respectively while dP_{PV} , dV_{PV} & dD denotes change in solar power, change in solar voltage and change in duty cycle respectively.

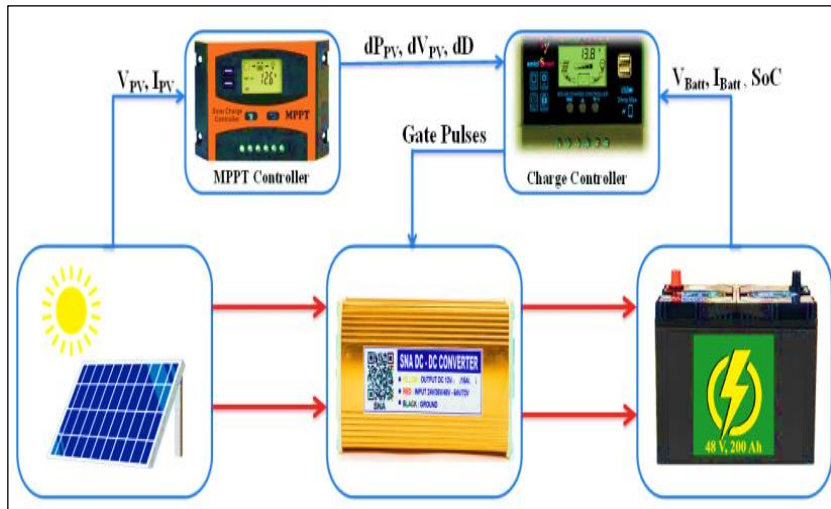

Figure 1: Block diagram of PV powered EV charging system with charge controller. Source: Authors, (2024).

Choosing the ideal charge controller for your system depends on understanding the different types and their functionalities. Each controller caters to specific needs and applications. Here's a breakdown of some common charge controllers

a. PWM (Pulse Width Modulation):

These controllers offer a basic approach, regulating the average current delivered to the battery by rapidly turning the charging current on and off. While cost-effective and suitable for small setups, PWM controllers can result in some energy loss compared to more advanced options. These types of controllers are ideal for low-power applications like small cabins, powering lights, or trickle charging batteries in RVs [2].

b. MPPT (Maximum Power Point Tracking):

MPPT controllers represent a significant leap in efficiency. They continuously analyse the voltage and current output from the solar panels (the charging source) and adjust their input to operate at the point of maximum power generation. This translates to significantly more power extracted from the solar panels, especially under fluctuating sunlight conditions. These types of controllers are perfectly suitable for larger standalone solar systems where maximizing power output is crucial, such as powering homes or telecom towers in remote locations [2].

c. Solar-Specific Charge Controllers:

These controllers are tailored for solar power systems. They account for the unique output characteristics of solar panels

and may include additional features. Examples include night-time disconnect to prevent battery drain during darkness and compatibility with various battery voltages. These are ideal for any solar PV system, particularly those with complex needs or diverse battery banks [3].

d. Multi-Stage Charge Controllers:

These advanced controllers implement a multi-stage charging process designed for specific battery chemistries. This process often involves stages like bulk charging, absorption charging, and float charging, each optimized to efficiently charge the battery and maximize its lifespan. These types of controllers are critical for systems using advanced battery technologies like lithium-ion, where precise charging profiles are essential for safety and longevity. They are also beneficial for lead-acid battery systems where maximizing lifespan is a priority [4].

II. METHODOLOGY

The solar photovoltaic (PV) system model with Maximum Power Point Tracking (MPPT) battery charge controller incorporates a PV array, a DC-DC converter, a battery, and an MPPT control block. This charge controller block generates a Pulse Width Modulation (PWM) control signal that regulates the switching device within the DC-DC converter [4].

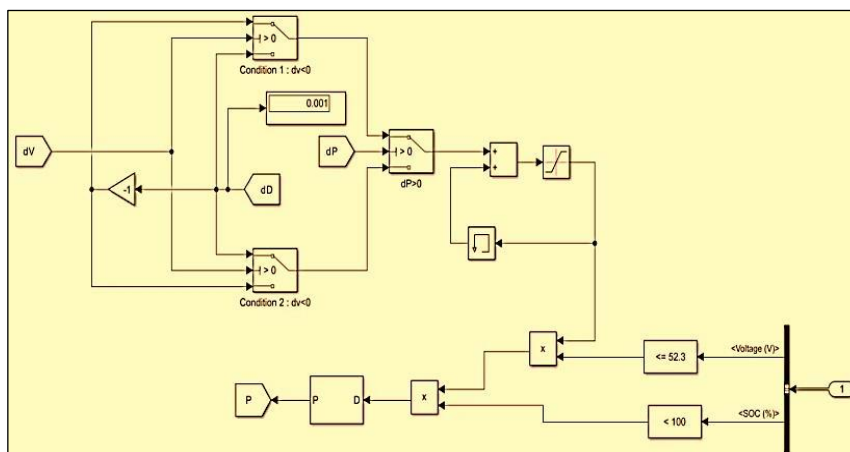

Figure 2: MATLAB/Simulink model of proposed charge controller. Source: Authors, (2024).

The control signal considers both MPPT input and battery data, as illustrated in Figure 1. The model is designed to charge a 48V, 200Ah battery using a 2kW PV array source. It's been simulated within the Simulink environment for performance evaluation. The following sections will delve deeper into the circuit model and the MPPT control block. An illustration of the MATLAB/Simulink model for the charge controller is provided in Figure 2.

A. Battery Charge Controller:

The charge controller implements a three-stage charging strategy to optimize battery health and performance. This strategy consists of Bulk Charging, Absorption charging & float charging. The flowchart depicting the charge controller's decision-making process is presented in Figure 3 [4-5].

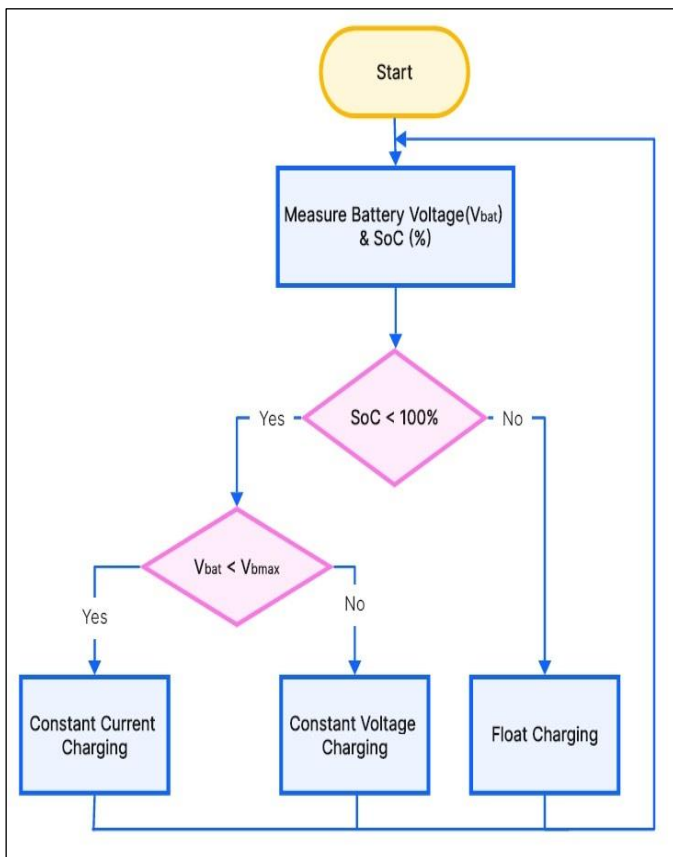

Figure 3: Flowchart depicting charge controller’s decision-making process.

Source: Authors, (2024).

During this initial stage, the controller delivers a constant current to the battery, typically set at the maximum power point tracking (MPPT) value. This stage aims to bring the battery voltage up to a predetermined level. Once the battery voltage reaches the designated set point (e.g., 52.3 V in this case), the controller transitions to constant voltage charging. Here, the voltage remains fixed while the current gradually declines as the battery approaches full capacity. This stage ensures a complete charge without overfilling. When the battery reaches full charge (100% State of Charge), the controller enters the float charging

stage. In this maintenance mode, a low voltage is applied to keep the battery topped up without the risk of overcharging, preventing gassing and overheating.

The controller continuously monitors the battery's SoC and voltage. Based on these values, it transitions between the charging stages. If the SoC is below 100% and the voltage is less than the set voltage (e.g., 52.3V), the controller initiates constant current charging. If the SoC is below 100% but the voltage exceeds the set point, the controller switches to absorption charging. Once the SoC reaches 100%, the controller enters the float stage to maintain a topped-up battery.

In order to assess the performance of charge controller, a standalone PV system alongside SEPIC & modified SEPIC topologies with charge controller are designed in MATLAB/Simulink environment. The outcomes of the calculations for each parameter of SEPIC and Modified SEPIC converters are summarized as Table 1 below, with input power of 2kW to charge a 48 V, 200 Ah battery at a switching frequency of 20 kHz [6-7].

Table 1: Parameters of SEPIC & Modified SEPIC Topologies.

S. No	Parameter	SEPIC Topology	Modified SEPIC Topology
1	Max. Duty Cycle (D _{Max})	64%	25.6 %
2	Min. Duty Cycle (D _{Min})	60.83%	21.7 %
3	Inductor (L ₁)	225 μH	7 mH
4	Inductor (L ₂)	350 μH	7 mH
5	Capacitor (C ₁)	410 μf	1.7 mf
6	Capacitor (C ₂)	264 μf	1.7 mf

Source: Authors, (2024).

III. SIMULATIONS AND RESULTS

This study compares the performance of SEPIC and modified SEPIC converters in a standalone solar photovoltaic (PV) system charging a 48V, 200Ah battery for an electric vehicle (EV). A charge controller is incorporated into the system for optimal battery management. The simulations are conducted within the MATLAB/Simulink environment. Both converter configurations are evaluated under identical test conditions. Key parameters monitored throughout the simulations include voltage, current, and power output from the PV panel. Additionally, the battery's state of charge (SoC), charging current, and voltage are tracked. Figures 4 to 15 present the MATLAB/Simulink models, along with detailed results for each converter type. These results include PV characteristics (voltage, current, and power), battery SoC, charging current, and voltage. The simulations further explore the effectiveness of both Perturb and Observe (P&O) and Incremental Conductance MPPT algorithms.

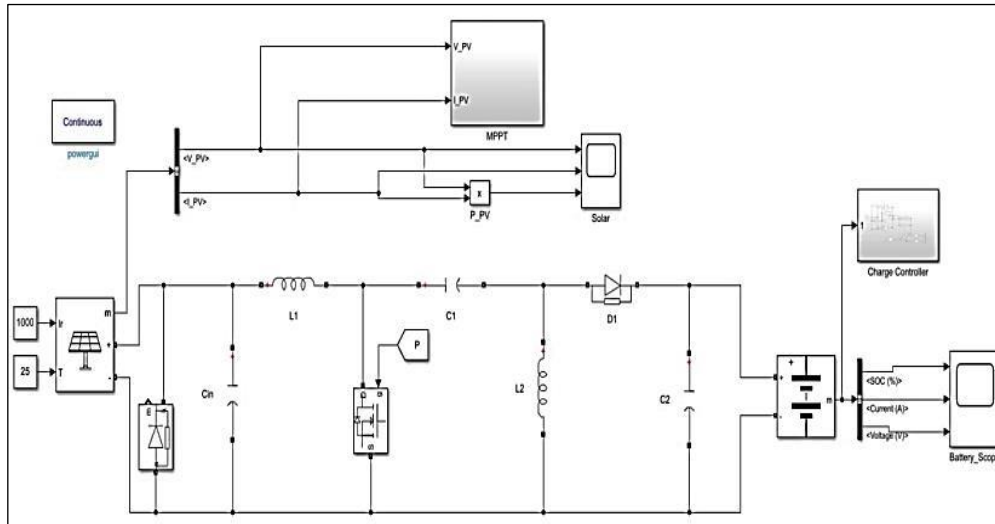

Figure 4: Simulink Model of SEPIC converter with Charge controller & PO MPPT.
Source: Authors, (2024).

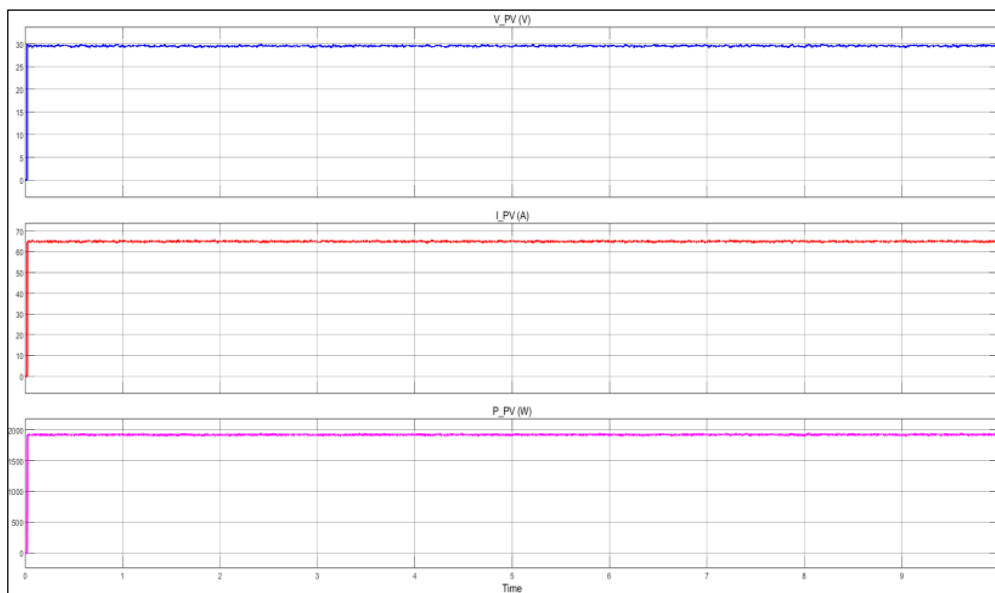

Figure 5: PV characteristics results for SEPIC converter with Charge controller & PO MPPT.
Source: Authors, (2024).

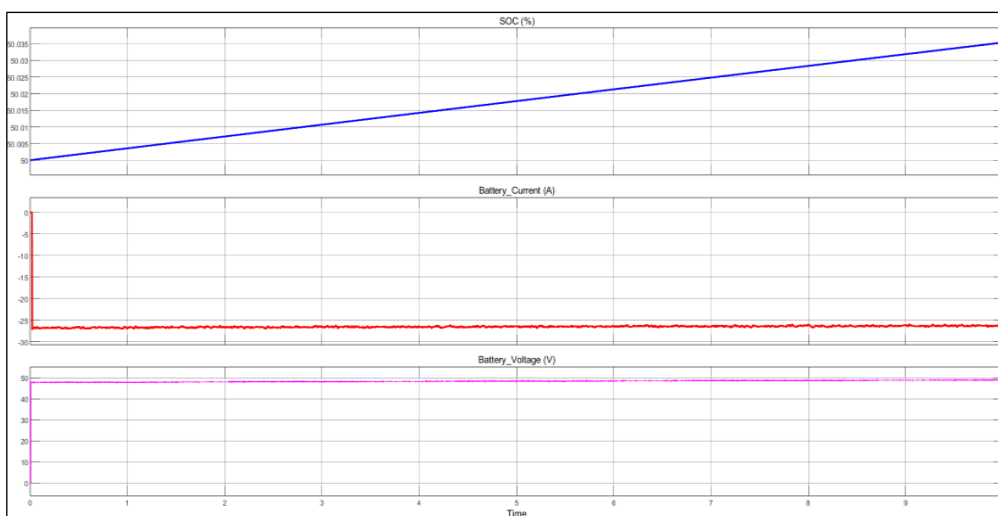

Figure 6: Battery charging results for SEPIC converter with Charge controller & PO MPPT.
Source: Authors, (2024).

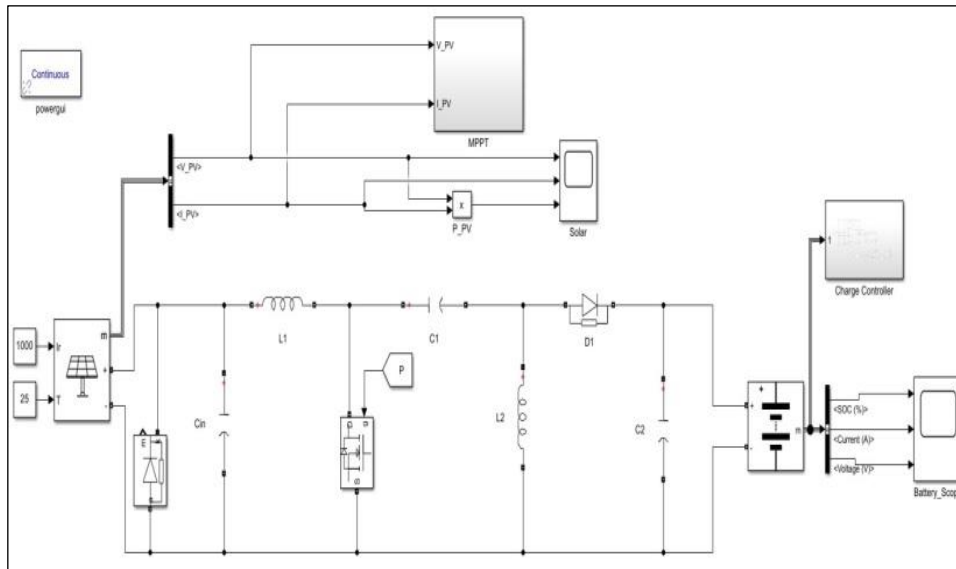

Figure 7: Simulink Model of SEPIC converter with Charge controller & INC MPPT.
Source: Authors, (2024).

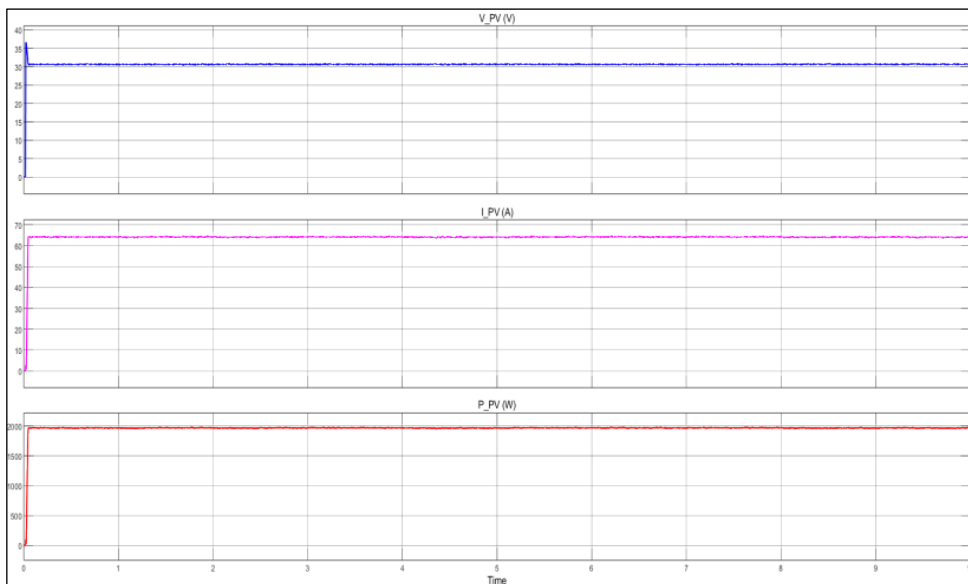

Figure 8: PV characteristics results for SEPIC converter with Charge controller & INC MPPT.
Source: Authors, (2024).

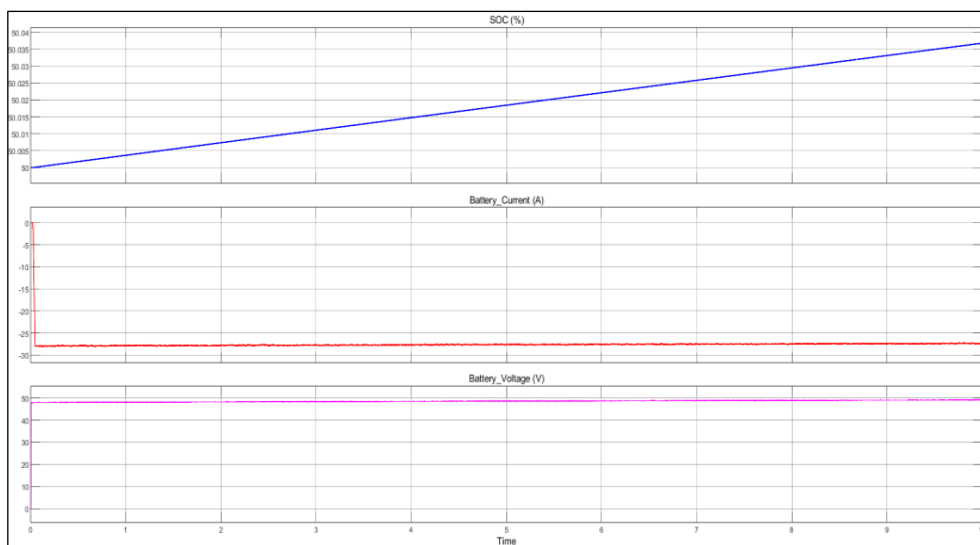

Figure 9: Battery charging results for SEPIC converter with Charge controller & INC MPPT.
Source: Authors, (2024).

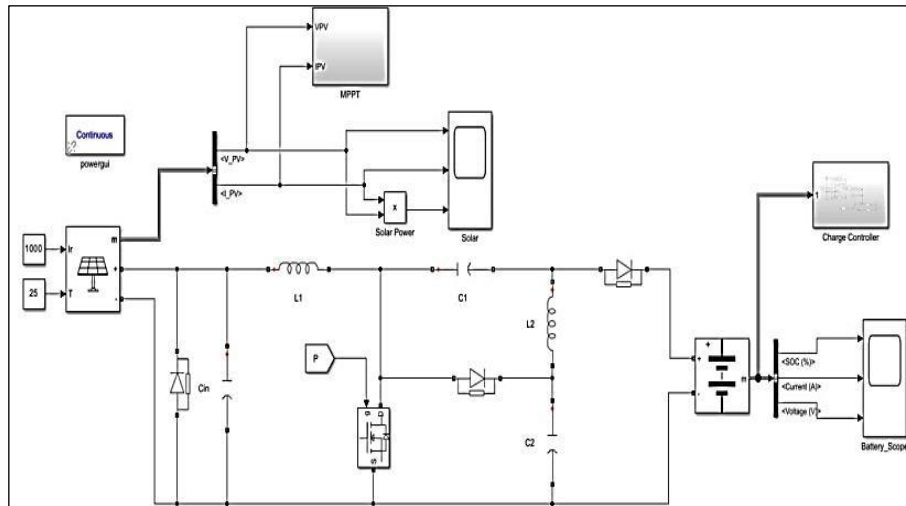

Figure 10: Simulink Model of Modified SEPIC converter with Charge controller & PO MPPT.
Source: Authors, (2024).

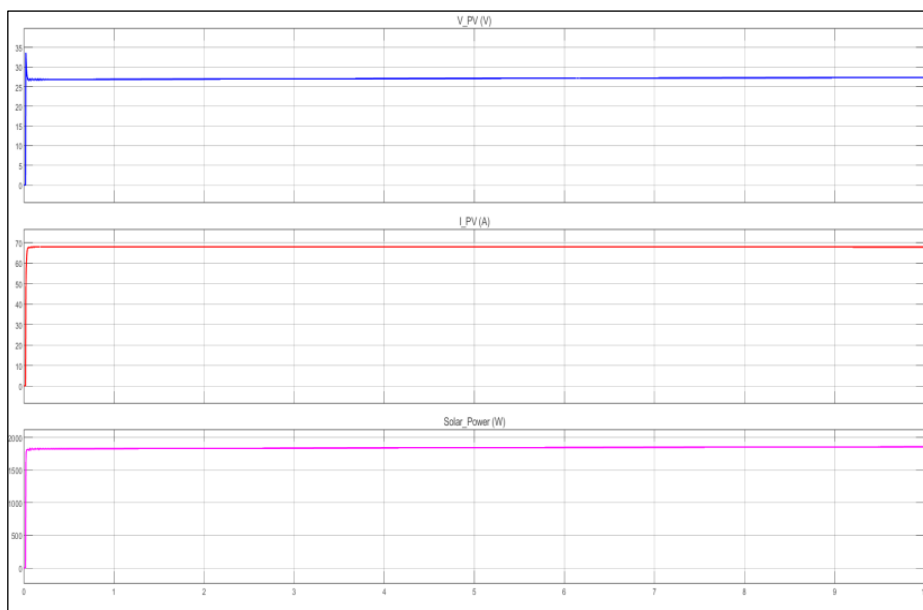

Figure 11: PV characteristics results for Modified SEPIC converter with Charge controller & PO MPPT.
Source: Authors, (2024).

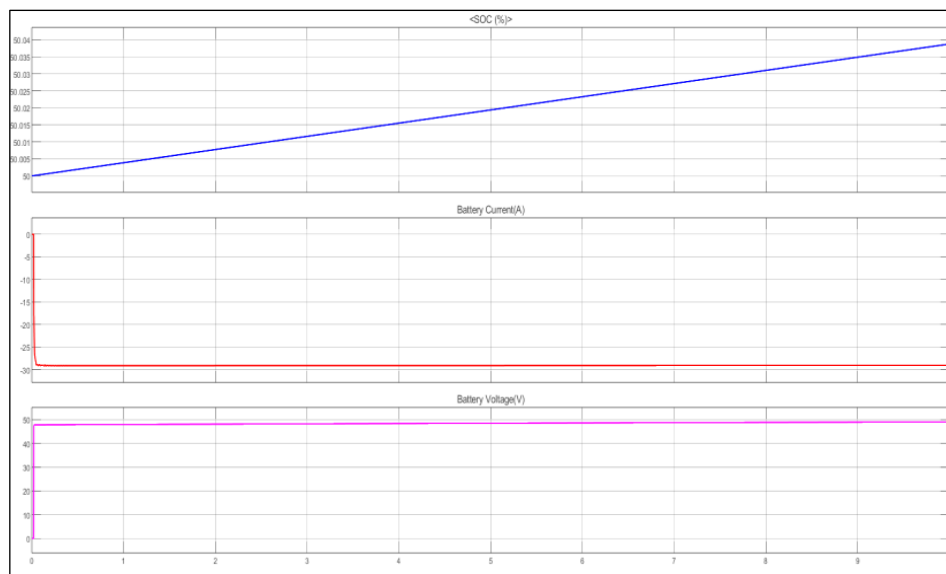

Figure 12: Battery charging results for Modified SEPIC converter with Charge controller & PO MPPT.
Source: Authors, (2024).

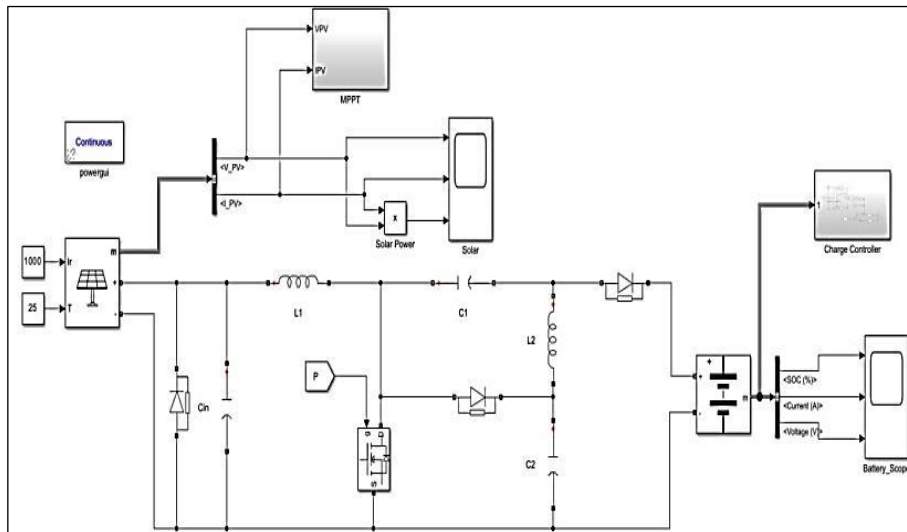

Figure 13: Simulink Model of Modified SEPIC converter with Charge controller & INC MPPT.
Source: Authors, (2024).

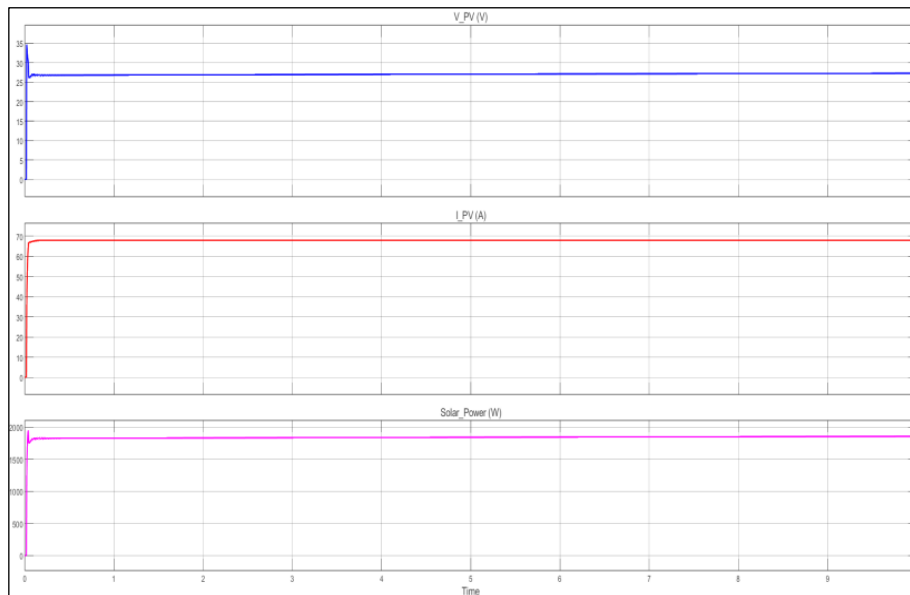

Figure 14: PV characteristics results for Modified SEPIC converter with Charge controller & INC MPPT.
Source: Authors, (2024).

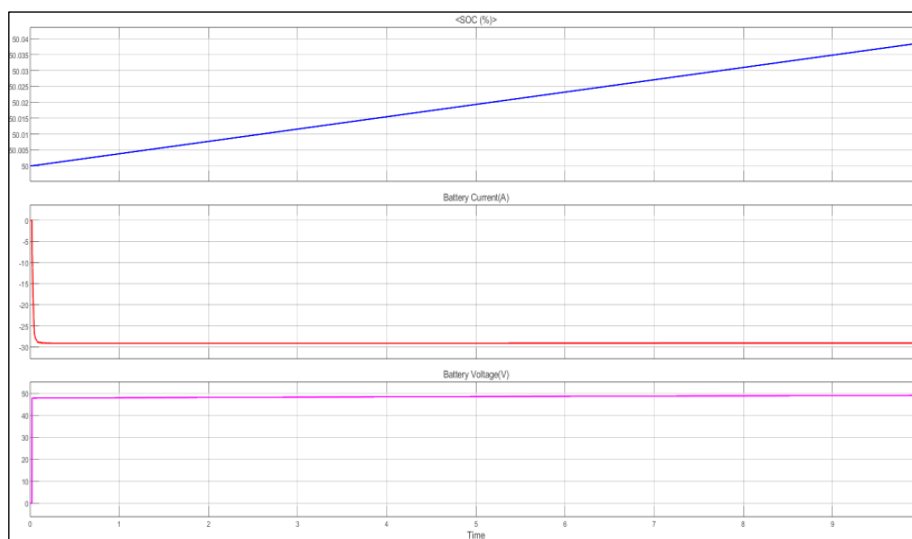

Figure 15: Battery charging results for Modified SEPIC converter with Charge controller & INC MPPT.
Source: Authors, (2024).

Table 2 presents a comparative analysis of the EV charging system's performance under identical test conditions. The analysis considers both SEPIC and modified SEPIC converters, with charge controller and implementation of Maximum Power Point Tracking (MPPT) methodologies. It's important to remember that negative battery current values signify the battery is actively charging.

Table 2: Simulation results with SoC of 50% and simulation time of 10sec.

parameter	SEPIC Converter		Modified SEPIC Converter	
	With P&O MPPT	With INC MPPT	With P&O MPPT	With INC MPPT
SoC (%)	50.035	50.037	50.039	50.039
V_b (V)	49.10	49.13	49.04	49.04
I_b (A)	-26.25	-27.36	-29.09	-29.09
V_{pv} (V)	29.46	30.61	27.31	27.31
I_{pv} (A)	65.09	64.15	67.92	67.92
P_{pv} (W)	1918	1964	1855	1855

Source: Authors, (2024).

IV. CONCLUSIONS

This study explores the detailed circuit modelling of a Solar PV MPPT battery charge controller built within MATLAB/Simulink environment. The explanation covers the MPPT tracking algorithm, the design of both the traditional SEPIC converter and a modified version, along with the three-stage charge controller. The model is comprehensive and allows for complete replication. This MPPT battery charge controller effectively manages the charging process for a 48V, 200Ah battery. It achieves this by tracking the maximum power output from a 2 kW PV array and utilizes a three-stage charging strategy to regulate the battery's state of charge.

The simulation results revealed that while both converter topologies achieved similar charging times, the modified SEPIC converter offered a significant improvement in efficiency. Specifically, the modified SEPIC converter achieved an overall efficiency of 77%, compared to 67.8% for the traditional SEPIC converter. This improvement in efficiency translates to faster charging times for a given power input, or less energy wasted during the charging process.

V. AUTHOR'S CONTRIBUTION

Conceptualization: Pavan Kumar Reddy Bondu, Vyza Usha Reddy, Dr.

Methodology: Pavan Kumar Reddy Bondu, Vyza Usha Reddy, Dr.

Investigation: Pavan Kumar Reddy Bondu, Vyza Usha Reddy, Dr.

Discussion of results: Pavan Kumar Reddy Bondu, Vyza Usha Reddy, Dr.

Writing – Original Draft: Pavan Kumar Reddy Bondu, Vyza Usha Reddy, Dr.

Writing – Review and Editing: Pavan Kumar Reddy Bondu, Vyza Usha Reddy.

Resources: Pavan Kumar Reddy Bondu, Vyza Usha Reddy.

Supervision: Pavan Kumar Reddy Bondu, Vyza Usha Reddy.

Approval of the final text: Pavan Kumar Reddy Bondu, Vyza Usha Reddy.

VI. ACKNOWLEDGMENTS

The authors would like to express their sincere gratitude to Sri Venkateswara University College of Engineering for providing necessary guidance and support.

We are also grateful to the anonymous reviewers for their constructive comments that helped us to improve the quality of this manuscript.

VII. REFERENCES

- [1] P. K. Atri, P. S. Modi and N. S. Gujar, "Design and Development of Solar Charge Controller by Implementing two different MPPT Algorithm," 2021 International Conference on Advances in Electrical, Computing, Communication and Sustainable Technologies (ICAECT), Bhilai, India, 2021, pp. 1-5, doi: <https://doi.org/10.1109/ICAECT49130.2021.9392426>
- [1] M. Deepika, P. Karthikeyan, A.V. Keerthana, M. Lakshmanan, P. Gowtham, C. Kumar and S. Jaisiva "MPPT-Based Charge Controller for Battery Fast Charging," 2023 9th International Conference on Advanced Computing and Communication Systems (ICACCS), Coimbatore, India, 2023, pp. 449-453, doi: <https://doi.org/10.1109/ICACCS57279.2023.10112852>
- [3] P. K. Abraham, D. Mary, M. V. Jayan and N. Paulson, "Design, Implementation, and Experimental Verification of a Solar PV Charge Controller for a Low-Speed E-Scooter Home Charging Station," 2023 9th International Conference on Smart Computing and Communications (ICSCC), Kochi, Kerala, India, 2023, pp. 754-759, doi: <https://doi.org/10.1109/ICSCC59169.2023.10334970>
- [4] Rodney H.G. Tan, Chee Kang Er and Sunil G. Solanki, "Modeling of Photovoltaic MPPT Lead Acid Battery Charge Controller for Standalone System Applications". E3S Web of Conferences. 182. 03005(2020). doi: <https://doi.org/10.1051/e3sconf/202018203005>
- [5] B. Pooja, S. Rajanna, N. L. Varaprasad, M. Ramesh, G. R. Sowmya and S. R. Rakshitha, "Design of a Battery Charge Controller Through MPPT Based Solar Photovoltaic System," 2022 Fourth International Conference on Emerging Research in Electronics, Computer Science and Technology (ICERECT), Mandya, India, 2022, pp. 1-6, doi: <https://doi.org/10.1109/ICERECT56837.2022.10060581>
- [6] A. K. Mishra and B. Singh, "Modified SEPIC Converter Utilizing an Improved P&O Algorithm for Design of Low Cost and Efficient Solar Energized Water Pump," 2018 IEEE Industry Applications Society Annual Meeting (IAS), Portland, OR, USA, 2018, pp. 1-8, <https://doi.org/10.1109/IAS.2018.8544680>
- [7] Bondu Pavan Kumar Reddy, V.Usha Reddy, "PV-Based Performance Evaluation of ZETA and SEPIC Topologies for EV Applications," Journal of Electrical Systems, vol.20, no. 5, pp. 438-446, 2024, <https://doi.org/10.52783/jes.2068>